

100% book - Year 10 Mainstream

Aim to memorise 100% of the knowledge on these Knowledge Organisers.



Term 1

Swindon Academy 2022-23	
Name:	
Tutor Group:	
Tutor & Room:	

"If you are not willing to learn, no one can help you.
If you are determined to learn, no one can stop you."

How to use your 100% book of Knowledge Organisers and Quizzable Organisers

Knowledge Organisers

Knowledge Organisers contain the essential knowledge that you **MUST** know in order to be successful this year and in all subsequent years.

They will help you learn, revise and retain what you have learnt in lessons in order to move the knowledge from your short-term memory to long-term memory.

Quizzable Knowledge Organisers

These are designed to help you quiz yourself on the essential Knowledge.

Use them to test yourself or get someone else to test you, until you are confident you can recall the information from memory.

Top Tip

Don't write on your Quizzable Knowledge Organisers! Quiz yourself by writing the missing words in your prep book. That way you can quiz yourself again and again!

Expectations for Prep and for using your Knowledge Organisers

1. Complete all prep work set in your subject prep book.
2. Bring your prep book to every lesson and ensure that you have completed all work by the deadline.
3. Take pride in your prep book – keep it neat and tidy.
4. Present work in your prep book to the same standard you are expected to do in class.
5. Ensure that your use of SPAG is accurate.
6. Write in blue or black pen and sketch in pencil.
7. Ensure every piece of work has a title and date.
8. Use a ruler for straight lines.
9. If you are unsure about the prep, speak to your teacher.
10. Review your prep work in green pen using the mark scheme.

How do I complete Knowledge Organiser Prep?

Step 1

Check Epraise and identify what words /definitions/facts you have been asked to learn. Find the Knowledge Organiser you need to use.

The image shows the Epraise website interface. On the left is a 'Planner' for the week of 20th May to 26th May 2020, with columns for Sun, Mon, Tue, Wed, Thu, and Fri. On the right is a 'Knowledge Organiser' for 'Particle Theory'. It contains various sections: 'What is particle theory?', 'What is the law of conservation of mass?', 'What are the different states of matter?', 'What are the differences between the states of matter?', and 'What are the differences between the states of matter?'. There are also diagrams of particle arrangements for solid, liquid, and gas.

Step 2

Write today's date and the title from your Knowledge Organiser in your Prep Book.

The image shows a printed page from a knowledge organiser. The date '29th May 2020' is handwritten at the top. The title 'Particle theory' is also handwritten. The page contains sections: 'A. What is particle theory?' (The theory that all matter is made up of particles), 'A. What is the law of conservation of mass?' (The Law of Conservation of Mass states that mass cannot be created or destroyed), 'B. What are the different changes of state?' (Melting, Freezing, Evaporation, Condensation), and 'What are the differences between the states of matter?'. There are diagrams of particle arrangements for solid, liquid, and gas, and a diagram showing energy changes during state transitions.

Step 3

Write out the keywords/definitions/facts from your Knowledge Organiser in FULL.

The image shows handwritten notes on lined paper. The date '29th May 2020' is written at the top. The title 'Properties of the states of matter' is written. The notes define 'Particle theory = all matter is made of particles'. It then describes the three states: 'Solid = regular pattern particles vibrate in fixed position', 'Liquid = particles are arranged randomly but are still touching each other Particles can slide past each other and move around.', and 'Gas = Particles are far apart and are arranged randomly. Particles carry a lot of energy'.

Step 4

Read the keywords/definitions/facts out loud to yourself again and again and write the keywords/definitions/facts at least 3 times.

The image shows handwritten notes on lined paper. It repeats the definitions of the three states of matter: 'Solid = regular pattern particles vibrate in fixed position', 'Liquid = particles are arranged randomly but are still touching each other Particles can slide past each other and move around.', and 'Gas = Particles are far apart and are arranged randomly. Particles carry a lot of energy'.

Step 5

Open your quizzable Knowledge Organiser. Write the missing words from your quizzable Knowledge organiser in your prep book.

The image shows a printed page from a quizzable knowledge organiser. The date '29th May 2020' is handwritten at the top. The title 'Self quizzing' is written. The page contains sections: 'A. What is particle theory?', 'A. What is the law of conservation of mass?', 'B. What are the different changes of state?', and 'What are the differences between the states of matter?'. There are diagrams of particle arrangements for solid, liquid, and gas, and a diagram showing energy changes during state transitions.

Step 6

Check your answers using your Knowledge Organiser. Repeat Steps 3 to 5 with any questions you got wrong until you are confident.

The image shows handwritten notes on lined paper. It repeats the definitions of the three states of matter, with checkmarks indicating correct answers and corrections. For example, 'Gas = Particles are far apart and are arranged randomly. Particles carry a lot of energy' has a checkmark. There are also corrections to the liquid definition: 'Liquid = particles are arranged randomly but are still touching each other Particles can slide past each other and move around.'

Make sure you bring in your completed Prep notes to demonstrate that you have completed your prep.

Year 10 - ENGLISH – Poetry cluster 1: The Romantics- Grammar

Key Vocabulary		Poem	Context	Events in the poem	Message	Form/ structure					
Tyrant	A cruel and unfair ruler	The Prelude-William Wordsworth	<ul style="list-style-type: none"> Born in 1770, Wordsworth was orphaned at 13 and sent to a grammar school. Whilst there, he was influenced by the countryside. The poem you study is just a section of an epic poem originally going to be called 'The Recluse'. The poem is mostly autobiographical. 	<ul style="list-style-type: none"> An autobiographical account of Wordsworth as a boy. The poem focusses on a boy stealing a boat and rowing it into the middle of a lake. Whilst there he feels as though nature is judging him and feels guilt for his theft. He returns the boat, but the memory stays with him 	<ul style="list-style-type: none"> Nature has the power to inspire and destroy and so should be respected. Nature can be overwhelming and render us feeling small and insignificant. It can remind us of our flaws and inspire us to do better. Imagination and memories are powerful. They can cause us to permanently change our outlook. 	<ul style="list-style-type: none"> The poem is written in blank verse and uses iambic pentameter to mimic the conversational flow of speech. It is not split into separate stanzas but flows continuously much like the power of nature over us. It is an epic poem (poems that 					
Transient	Lasting for only a short time										
Hubris	Having extreme pride or self-confidence										
Oppression	When leaders treat people in a cruel or unfair way over a long period of time.										
Patriarchy	A society where men have the most power and control										
Egocentric	Thinking only of oneself										
Awe	A feeling of deep respect mixed with fear or wonder	My Last Duchess-Robert Browning	<ul style="list-style-type: none"> Browning was inspired by the writing of radical poets such as Shelley Written in 1834, it is inspired by the actions of an Italian duke who married a young girl, who died in suspicious circumstances. Browning moved to Italy to marry his wife because of her overprotective father. As a result, he was familiar with over-controlling patriarchs. 	<ul style="list-style-type: none"> The speaker of the poem (the Duke) shows a visitor through his palace. He stops before a portrait of the late Duchess who has died. The Duke reminisces about the portrait sessions and about the Duchess. His musings give way to a rant about her disgraceful behaviour: he claims she flirted with everyone and did not appreciate his "gift of a nine-hundred-years- old name." As his monologue continues, the reader realises that the Duke caused the Duchess's early death: when her behaviour escalated, "[he] gave commands; / Then all smiles stopped together." Having made this admission, the Duke returns to the business at hand: arranging another marriage, with another young girl. 	<ul style="list-style-type: none"> Browning makes us question whether the expectations of society are too oppressive, especially for women; strict rules should not be imposed on others and there should be equality of power in society. The power of humans is exposed as having potential dangers and Browning warns us that evil can take many forms – we should not be deceived by the outward appearance of someone; anyone can be cruel. Furthermore, Browning shows how unattractive arrogance is; it can lead to the abuse of power. He warns us of the consuming nature of pride and jealousy: they can take over 	<ul style="list-style-type: none"> Dramatic monologue- reflective of the Duke's egocentricity The regular meter and rhyme scheme (rhyming couplets) demonstrate the Duke's control over the narrative and how he has carefully constructed his argument. However, some of the rhyming couplets are subdued by enjambment so are hidden when listening to the poem. This is reflective of the Duke's true nature. Beneath his wealth and status, he is no more than a murderous villain. There are no breaks in the poem to split it into stanzas. This could symbolize the lack of gaps in his fortress. In a patriarchal society, a man of such a high status is protected from the repercussions of his actions. 					
Radical	Wanting to see extreme changes in politics and society										
Ephemeral	Lasting a very short time										
Autocratic	A ruler who has complete power and makes decisions without asking anyone else's advice										
Sinister	Something that seems evil or harmful										
Revolution	A large group of people using force to change the political system of their country										
Exploit	Treating someone unfairly in order to benefit from them.	Ozymandias- Percy Shelley	<ul style="list-style-type: none"> Shelley was considered to be a radical due to his atheism and his opposition of the church and monarchy The poem is inspired by an Egyptian pharaoh, Rameses II. Rameses II was remembered for leading armies into many battles and building a huge empire. However, to do this he used slave labour and allowed his people to struggle whilst he invested huge sums of money into expanding his kingdom. 	<ul style="list-style-type: none"> The poem imagines a traveler describing the broken statue of Ozymandias in the vast expanse of the empty desert. In the poem, the tyrannical Rameses II believed himself to be 'king of kings' and that his power would be eternal. However, where a great empire once stood, now only sand and ruins remain. Shelley uses the poem to demonstrate the transient nature of political power and as a metaphor for his opposition of the Establishment's power. 	<ul style="list-style-type: none"> Shelley wanted to communicate how all power is transient – even powerful individuals are no match against nature and time. Shelley warns tyrants that they are vulnerable; they should not be arrogant, but instead be humble and accept their own limitations and the ephemeral nature of their power. The poem offers hope to ordinary people as they are reminded that no one's power can last forever. Shelley reminds us that the power of art and artists endures over the power of kings – particularly tyrants. 	<ul style="list-style-type: none"> Sonnet- Sonnets are typically love poems written in iambic pentameter. They are 14 lines long and have a strict rhyme scheme. The use of the sonnet form is reflective of Rameses' love of power whilst the rigid structure is symbolic of both Ozymandias' oppressive rulership. It could also reflect the poet's lasting power and control over the way we remember Ozymandias – far outlasting the power of Rameses II. Shelley also breaks the conventional sonnet form which could symbolise how the power of tyrants is ephemeral. 					
Anti-establishment	Disagreeing with the people who have power and make decisions										
Romanticism:											
<p>A movement in literature and the arts From around 1800-1890</p> <p>During this time, major transitions took place in society, as dissatisfied intellectuals and artists challenged the Establishment (the church and the monarchy). The Romantics valued freedom, imagination, emotion and nature</p> <p>They were critical of power that institutions (such as the church and monarchy) had as they believed that they exploited the poor and restricted people's freedoms</p>											
							London-William Blake	<ul style="list-style-type: none"> Born in London in 1757, Blake was anti-establishment and opposed many of the things he saw in London. He believed that the government, the church and the monarchy were to blame for the widespread suffering he saw on London's streets. During this era, life was difficult for the poor. There was much sickness, disease and the children of poor parents would have had to work hard and dangerous jobs, such as chimney sweeping. 	<ul style="list-style-type: none"> Walking through through London's streets, the speaker notices how the course of the Thames seems to be dictated as it flows through the city. The speaker sees sadness in the faces of every person he passes and hears pain in every voice in the city. Every law and restriction oppresses the people of London. He hears the cry of young chimney-sweeps, whose misery brings shame on the Church authorities. Thinking of British soldiers dying in vain, the speaker imagines their blood running down the walls of a palace. He also hears the cries of young prostitutes, who curse at their situation. This miserable sound brings misery to their tearful new-born children. The speaker also imagines this sound plaguing what the speaker calls "the Marriage hearse"—a surreal imagined vehicle that carries love and death together. 	<ul style="list-style-type: none"> Blake wanted to highlight the desperate suffering of the poor in 19th century Britain. Blake believed people should be supported and cared for by institutions of power such as the church, the government and the education system. Blake was appalled that people endured such difficulties and wanted them to break free from the oppressive control. It could be said to be his call to revolution as he subtly hints at the French revolution in which people stood up against oppressive rulership. 	<ul style="list-style-type: none"> Blake uses regular stanzas and a regular rhyme scheme which reflects the monotony of the pain and suffering that the people of London face. The controlled structure is also symbolic of the control that the Establishment has over society.

Year 10 - ENGLISH – Poetry cluster 1: The Romantics- Grammar

Key Vocabulary		Poem	Context	Events in the poem	Message	Form/ structure
	A cruel and unfair ruler	The Prelude- William Wordsworth	<ul style="list-style-type: none"> Born in _____, Wordsworth was... Whilst he was there, he was influenced by ... The poem you study is... The poem is mostly... 	<ul style="list-style-type: none"> An _____ account of... The poem focusses on... Whilst there he feels... He... 	<ul style="list-style-type: none"> Nature has the power to... Nature can be ... Imagination and memories are... 	The poem is written in blank verse and uses iambic pentameter to mimic the conversational flow of speech. It is not split into separate stanzas but flows continuously- much like the power of nature over us.
	Lasting for only a short time					
	Having extreme pride or self-confidence					
	When leaders treat people in a cruel or unfair way over a long period of time.					
	A society where men have the most power and control	My Last Duchess- Robert Browning	<ul style="list-style-type: none"> Browning was inspired by... Written in _____, it is inspired by 	<ul style="list-style-type: none"> The speaker of the poem (the Duke) shows... The Duke talks about... As his monologue continues, the reader realises that... Having made this admission, the Duke... 	<ul style="list-style-type: none"> Browning questions... Browning warns us that... Furthermore, Browning shows how... 	Dramatic monologue- The regular meter and rhyme scheme (rhyming couplets) demonstrate
	Thinking only of oneself					
	A feeling of deep respect mixed with fear or wonder					
	Wanting to see extreme changes in politics and society					
	Lasting a very short time					
	A ruler who has complete power and makes decisions without asking anyone else's advice					
	Something that seems evil or harmful	Ozymandias- Percy Shelley	<ul style="list-style-type: none"> Shelley was considered to be... The poem is inspired by... He... 	<ul style="list-style-type: none"> The poem imagines... In the poem,... However... 	<ul style="list-style-type: none"> Shelley wanted to... Shelley warns tyrants that... The poem offers... 	Sonnet- The use of the sonnet form is reflective of The rigid structure is symbolic of
	A large group of people using force to change the political system of their country					
	Treating someone unfairly in order to benefit from them.					
	Disagreeing with the people who have power and make decisions					
Romanticism:		London- William Blake	<ul style="list-style-type: none"> Born in London in _____, Blake was... He believed... During this era,... 	<ul style="list-style-type: none"> Walking through ... The speaker sees... He hears... Thinking of... He also hears... 	<ul style="list-style-type: none"> Blake wanted to... Blake believed... Blake was... It could be said to be... 	Blake uses regular stanzas and a regular rhyme scheme which reflects The controlled structure is also symbolic of
A movement in literature and the arts From around _____ During this time, major transitions took place in society, as dissatisfied _____ and _____ challenged the _____ (the church and the monarchy). The Romantics valued _____, _____, _____ and _____ They were _____ of power that institutions (such as the church and monarchy) had as they believed that they _____						



T1 Y10 P1.3 – Mainstream Higher Energy Resources

Vocabulary: generation

Energy resources

We use energy resources for electricity generation, transport and heating

Non-renewable – ones that are being used faster than they can be replaced and will run out.

Example	+	-
Coal, oil, natural gas	Reliable method of generating electricity	Release CO ₂ which contributes to global warming
nuclear	No CO ₂ released	Produces radioactive nuclear waste

Renewable resources:

Ones that will not run out , they are being replenished as they are used

Example	+	-
Solar	No CO ₂ released	Don't work at night or well on cloudy days
wind	No CO ₂ released	Doesn't work if it isn't windy
Hydro	No CO ₂ released	Damage to habitats
Geothermal	No CO ₂ released	Only found in specific places
waves	No CO ₂ released	Damage to habitats
Biofuel	Carbon neutral	Uses crop land to grow new forests

NOW QUIZ YOURSELF

1. Give the three main uses for energy resources
2. What is a non-renewable energy resource?
3. Give 2 examples of non-renewable energy resources
4. Give two disadvantages of using coal and oil
5. Give one advantage to using nuclear resources to generate electricity.
6. What is a renewable energy resource?
7. Give 4 examples of renewable resources
8. Give 2 advantages of using renewable resources to generate electricity
9. Give two disadvantages of using renewable resources to generate electricity

T1 Y10 B2.6 Mainstream Higher – Preventing and treating diseases

Vocabulary: Clinical Placebo

Antibiotics & Painkillers

Antibiotics = kill bacteria (specific antibiotic for specific bacteria)

THEY DO NOT KILL VIRUSES

e.g. penicillin

Antibiotics cannot kill viruses because viruses live inside cells

Painkillers = stop pain (don't kill microbes, just help with symptoms)

e.g. paracetamol

Vaccination

- Introducing small quantities of dead or inactive forms of pathogen into the body.
- Stimulates WBCs to produce antibodies.

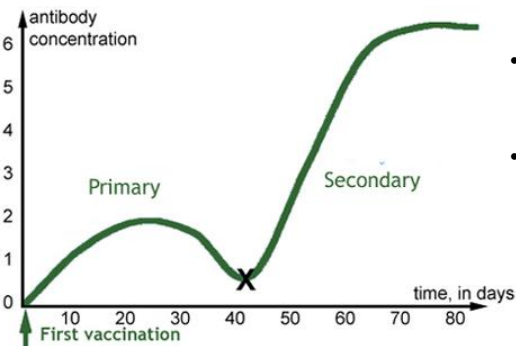

- If same pathogen returns (X), WBCs remember how to make the right antibodies.
- They make MORE antibodies, MORE QUICKLY, and they stay in body for LONGER.

1. What is the only type of pathogen antibiotics can kill?
2. What do painkillers do?
3. Why can antibiotics NOT kill viruses?
4. What is in a vaccination?
5. Why do the white blood cells respond more quickly the second time they come into contact with a pathogen?
6. How does vaccination prevent us from becoming infected with the same pathogen in the future?

Development of Drugs

Testing for:

- Safety, Efficacy (does it work), Dosage (how much is needed)

Stage		Description
1	pre-clinical	Tested on cells and tissues. Side effects? Efficacy?
2		Tested on animals. Side effects?
3	clinical	Clinical trials = tested on humans. 1 st health volunteers, 2 nd patients with the illness. Dosage gradually increased to optimum.

White Blood Cells (WBCs)

1. Phagocytosis – engulfing the pathogen
2. Producing antibodies – specific to the antigen
3. Producing antitoxins – to neutralise toxins

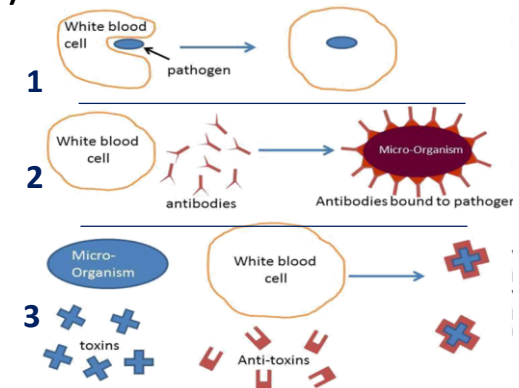

1. What are clinical trials?
2. What are the three things we test for before a drug can be used by the public?
3. What is the first stage of drug testing?
4. What are drugs tested on in preclinical trials?
5. What is phagocytosis?
6. What do antibodies attach to?
7. How do antitoxins make us feel better?



T1 Y10 B2.7 Mainstream Higher - Non-communicable

Coronary Heart Disease (CHD)

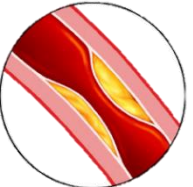

- Coronary arteries supply heart muscle with blood (containing glucose and oxygen for respiration)
- Can become narrowed/blocked by fatty deposits if cholesterol high, reducing blood flow.
- Reduced muscle contraction in heart

Faulty Valves

- Valves in veins and the heart prevent backflow of blood
- Faulty valves = don't open or close fully
- Can be replaced with man-made valves or transplants from donors

faulty



DOESN'T CLOSE PROPERLY

healthy



NORMALLY CLOSED

Interaction of Diseases

- Defects in the immune system - individual is more likely to suffer from infectious diseases.
- Viruses can trigger cancers, e.g. HPV can trigger cervical cancer.
- Immune reactions caused by pathogens can trigger allergies such as asthma or rashes
- Severe physical ill health can lead to depression and other mental illness.

Heart Disease Treatment – Statins vs Stents

Statins	Stents
<ul style="list-style-type: none"> • Medication to be taken everyday • Lowers blood cholesterol • Does not work immediately 	<ul style="list-style-type: none"> • Mesh tube to be inserted into artery to hold it open • Surgery required • Works immediately



Risk Factors

Lifestyle factors can have be risk factors for certain diseases. E.g. obesity is a risk factor for type 2 diabetes, or drinking and smoking while pregnant affects the development of the foetus.

Cancer

Uncontrolled cell growth

Benign tumours = abnormal cells, contained in one area, in a membrane, do not invade other parts of body.

Malignant tumours = cancer cells, not in a capsule, invade neighbouring tissue, and spread into blood and form secondary tumours.



T1 Y10 B2.7 Mainstream Higher - Non-communicable

1. What do coronary arteries do?
2. What can block coronary arteries?
3. What will happen to the heart if they become blocked?

1. What is the job of a valve?
2. How can faulty valves be treated?

1. Give an example of when cancer can be triggered by a virus.
2. Give an example of an immune reaction that can be triggered by a pathogen

1. How do stents treat CHD?
2. How do statins treat CHD?
3. Give an advantage of using stents rather than statins to treat CHD

1. Name a disease linked with obesity

1. What is a benign tumour?
2. Why do benign tumours not spread?
3. How can malignant tumours spread?

T1 Y10 P2.4 Mainstream Higher – Electrical circuits Vocabulary: Potential difference, Thermister

Current, resistance and potential difference

Electrical current is the flow of electrical charge.

Current is measured in amps (A), charge is measured in Coulombs (C).

The size of the current depends on the rate of the flow of charge – ie how many coulombs of charge per second.

$$Q = I t$$

Charge = Current x time
(C) (A) (s)

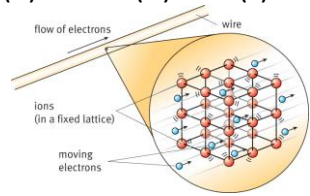

Ohms Law

The current through a component depends on the potential difference and the resistance of the component.

If a component has high resistance, the current will be smaller for a given potential difference

potential difference = current x resistance

$$V = I R$$

pd is measured in volts (V), resistance in Ohms (Ω)

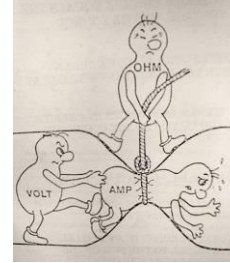

Series and parallel circuits

Series circuits:

A series circuit is one single loop

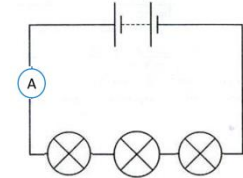

In a series circuit:

- the current is the same at all points in the circuit.
- potential difference is shared between components (equally if components are identical resistance)
- total resistance = sum of all resistors

Hypothesis 'the length of the wire affects resistance'

Independent variable – length of wire

Dependent variable – resistance

Control variables – type of wire, temperature of the wire, diameter of the wire

1. Set up the circuit as shown, with an ammeter in the circuit and a voltmeter connected across the wire
2. Use crocodile clips to change the length of the wire in the circuit
3. Make the wire 10cm long and read the current and pd. Switch off the current between readings or the wire will get hot, increasing the resistance.
4. Repeat for 20, 30, 40, 50 cm. (5 minimum)
5. Calculate resistance using Ohms Law $R = V/I$

Plot length of wire (IV) against resistance (DV)

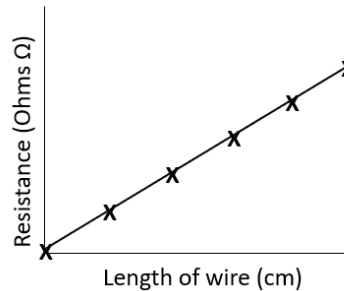
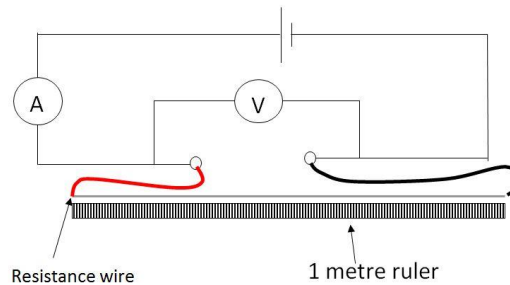

The relationship is directly proportional

Parallel circuits

A parallel circuit consists of more than one loop from the battery/cell.

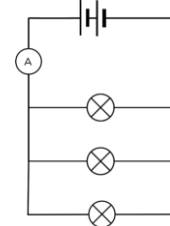

In a parallel circuit:

- The current is shared amongst the branches
- The potential difference is the same across all components
- Resistance in the whole circuit is LESS than that of the smallest resistor

T1 Y10 P2.4 Mainstream Higher – Electrical circuits

Current, resistance and potential difference

1. What is current?
2. What is the unit for charge?
3. What is the unit for current?
4. What is the equation linking charge, current and time?
5. What is the equation linking current, potential difference and voltage?
6. If a component's resistance increases, what happens to current through that component?
7. What is the unit for resistance?

Hypothesis 'the length of the wire affects resistance'

1. What is the independent variable in this investigation?
2. What is the dependent variable?
3. What is the minimum number of readings needed for a line graph?
4. What two readings are taken?
5. How is resistance calculated?
6. What sort of relationship is seen?
7. Why is it important to turn off the power in between readings?

Series and parallel circuits

1. What is a series circuit?
2. In a series circuit, the current is.....
3. How do you find total resistance in a series circuit?
4. The potential difference is shared equally among components as long as.....
5. What is a parallel circuit?
6. What is true about potential difference across all of the components in a parallel circuit?
7. How is total current calculated in parallel?
8. What is true for total resistance in a parallel circuit?

T1 Y10 P2.4 Mainstream Higher – Electrical circuits

Components

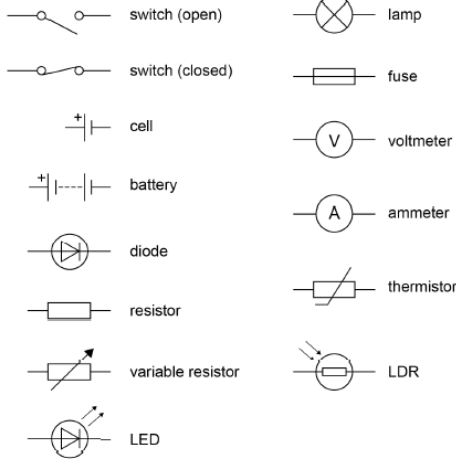

- A **diode** only allows current to flow one way in a circuit
- A **resistor** is a component that provides a fixed resistance in the circuit – e.g a 5 Ω resistor
- A **variable resistor** is a component whose resistance can be changed (e.g a dimmer switch)
- A **thermistor** is a resistor whose resistance changes with temperature – the higher the temperature the lower the resistance
- An **LDR** (light dependent resistor) has resistance that changes
- An **LED** (light emitting diode) is a light that only allows the flow of current one way

LDR

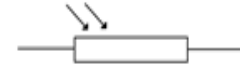

A light dependent resistor has varying resistance.
As the light intensity increases, the resistance decreases

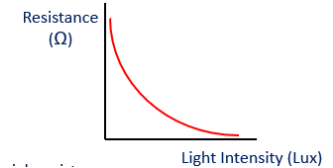

LDRs can be used to switch on lights at night time.

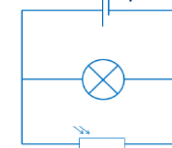

In this circuit, when it is day time, the resistance in the LDR is low, so all current flows through the LDR.

As light levels fall, resistance increases, until eventually there is less resistance in the bulb than the LDR, so current flows through the bulb – switching it on.

Thermistor

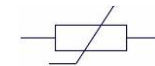

As the temperature increases, the resistance in a thermistor decreases.

Current, potential difference and resistance for different components

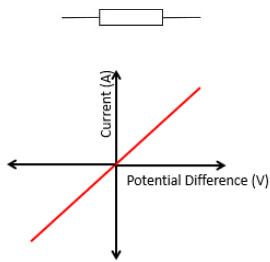

A fixed (ohmic) resistor has fixed resistance
current is directly proportional to potential difference
Resistance remains constant (at constant temp)

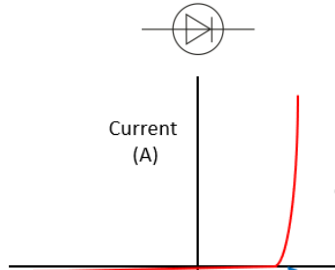

A diode very high resistance in one direction.
Only when the potential difference is positive does current flow

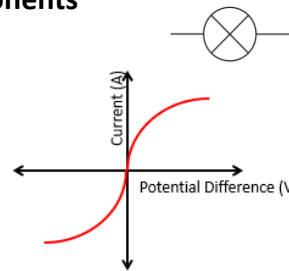

A filament bulb contains a thin wire that glows as current flows.
As the pd increases, the current initially increases.
However, at higher pd, the wire gets hot
The ions in the wire move faster and collide with the moving charges
Resistance increases, so current stops increasing

T1 Y10 P2.4 Mainstream Higher – Electrical circuits

Components

Symbol	Name
	Cell
	fuse
	Voltmeter

1. Complete the table opposite
2. Which component has a resistance that decreases as light intensity increases?
3. Which component only allows current to flow one way?
4. What is a fixed resistor?

LDR

1. Draw the symbol for an LDR
2. Draw the pattern you would expect for resistance as the light intensity increases.
3. The circuit below is for a night light. What is resistance in the LDR like during the day time? (high light levels)

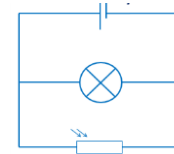

4. Why does the light switch on when it goes dark?
5. Draw the symbol for a thermistor
6. Describe the relationship between temperature and resistance in a thermistor

Current, potential difference and resistance for different components

1. What readings would you need to take from a circuit to calculate resistance?

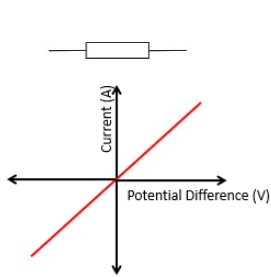

2. Describe the relationship shown

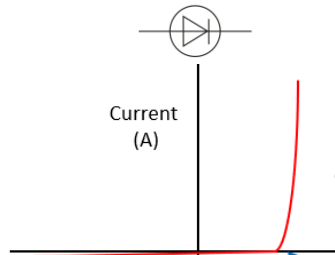

3. Why is there no current on one side of the graph?

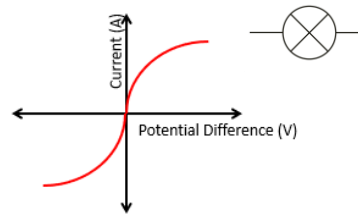

4. What happens to current when the pd rises at first ?
5. What happens to the current as the pd gets higher?
6. Why does the resistance increase at higher pd?

T1 Y10 P2.5 Mainstream Higher– Electricity in the home

Domestic use of electricity

There are two types of electrical supply – direct (DC) and alternating current (AC)

AC

The pd changes direction and magnitude, giving alternating current

The number of times the change of direction happens per second is the frequency.

UK mains is AC - **230V**

Frequency of **50 Hz**

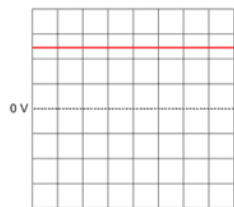
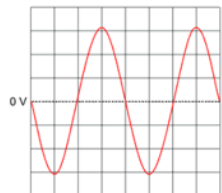

DC

A direct pd produces current that flows in one direction

Batteries supply DC

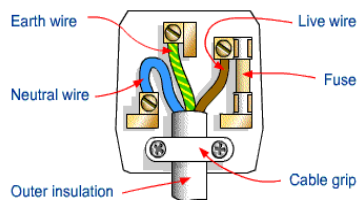

Electrical appliances are connected using 3 core cable

- Brown – live wire, with pd of 230V
- Blue – neutral, 0V, completes the circuit
- Yellow and green – Earth wire, is at 0V unless there is a fault, when it will become live

Appliances in the home and power

Power is measured in Watts (W) or kW

Power can be calculated by using:

Power = Voltage x current

$$P = IV$$

Power = current² x resistance

$$P = I^2 R$$

Appliances transfer energy.

Energy is measured in Joules (J) or kJ

The energy transferred can be calculated by using:

Energy = charge flow x potential difference

$$E = Q V$$

Energy = power x time

$$E = p t$$

For example

A kettle transfers energy from the thermal store of the filament in the kettle to the thermal store of the water inside.

Some energy is transferred to the thermal store of the surroundings.

The National Grid

The National Grid is a system of cables and transformers connecting power stations to homes and businesses

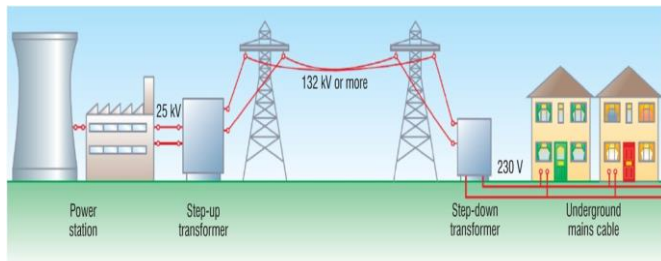

The National Grid uses very high pd and low current.

High current causes heating in the wires and would result in large energy losses.

Step up transformers increase the pd from the power station (to around 400000V) so that low current can be used to transmit power.

This means the wires don't get hot, so less energy is lost.

Near homes and businesses, step down transformers reduce the pd to 230V for safety.

I1 Y10 P2.5 Mainstream Higher – Electricity in the home**Domestic use of electricity**

1. What are the two types of current?
2. What type of power supply produces DC current?
3. What are the two differences between AC and DC current?
4. What is the pd of the UK mains supply?
5. What is the frequency of UK mains supply?
6. What colour is the live wire in UK plugs?
7. What is the purpose of the blue wire in UK plugs?
8. When does the yellow and green wire carry a current?

The National Grid

1. What is the National Grid?
2. What sort of pd does the National Grid use to transmit electrical power?
3. What is used to increase the pd from the power station?
4. What is used to reduce the pd near homes and businesses?
5. Why is such a high pd used?

Appliances in the home and power

1. What is the equation linking current, potential difference and power?
2. What is the equation linking current, resistance and power?
3. What two factors affect how much energy an appliance transfers?
4. What is the equation linking energy, power and time?
5. What are the units for power?
6. What is the equation linking charge, energy and potential difference?
7. What are the units for energy?



1. Global pattern of urban change

The world's population is growing rapidly; currently 50% of us live in urban areas.

Urbanisation	An increasing percentage of a country's population living in towns and cities.
HICs	Very slow rate of urbanisation. Already have high urban populations. Urbanisation happened earlier (during the industrial revolution).
NEEs	Fast rate of urbanisation due to industrialisation. Urban population is increasing rapidly.
LICs	Fast rate of urbanisation. Urban population is low as many still work in farming.

2. Factors affecting urbanisation

Rural-Urban migration	The movement of people from a rural area (countryside) to an urban area (towns and cities).
Push factors	Negative factors that make people leave an area e.g. drought, famine, war, few services.
Pull factors	Positive factors that attract people to an area e.g. better access to services, better paid jobs, access to electricity.
Natural Increase	When the birth rate is higher than death rate; the population grows. High in NEE cities as migrants are often young and health care is improving.

3. Megacities

Megacity	A city of more than 10 million people living there.
How many?	There are now 34. Rapidly increasing.
Where?	Most are in Africa and Asia.

4. Key terms

Social deprivation	The extent an individual or an area lacks services, decent housing, adequate income and employment.
Dereliction	Abandoned buildings and wasteland.
Urban Greening	Process of increasing and preserving open space in urban areas i.e. parks.
Urban sprawl	Unplanned growth of urban areas into surrounding rural areas.
Integrated Transport System	Different forms of transport are linked together to make it easy to transfer from one to another.
Brownfield	Land that has been used, abandoned and now awaits reuse; they are often found in urban areas.
Greenfield	A plot of land, often in rural areas or on the edges of urban areas that has not been built on before.
Commuter settlements	A place where people live but travel elsewhere for work e.g. Yate → Bristol.

5. Sustainable urban living

Sustainable urban living	Where people living, now, have the things they need, without reducing the ability of people in future to meet their needs.
Water conservation	Recycling grey water. ½ flush toilets. Rainwater harvesting on roofs. Permeable pavements- filters pollutants.
Energy conservation	Energy efficient appliances. Energy saving (south facing windows). Use of renewable energy sources.
Waste recycling	Recycling boxes in houses. Recycling facilities nearby. Encourage websites like 'Freecycle'.
Creating green space	Maintain green spaces around towns- Cools area, encourage exercise, happy.

6. Urban transport strategies used to reduce traffic congestion

Problems with congestion	↗ air pollution (global warming). Late for work, deliveries delayed. ↗ accidents, stress, asthma. In Bristol, 200 people die as a result of air pollution each year.
Beryl Bikes	Shared bikes in Bournemouth + Poole.
Oyster Cards	Quick and easy to pay for more than one type of public transport (London).
Park and ride	Car parks on the outskirts of a town, with buses into the city centre.
Congestion charge	Charge for entering the city centre at peak times.
Bus lanes	Stop buses being held in traffic.



7. Distribution of population and major cities in the UK

Population	66 million. Distribution is very uneven. 82% live in urban areas. Upland areas are sparsely populated.
Cities	Most in lowland areas and on coasts. London is the biggest city and the capital. It has 10% of the population. Cities reflect our industrial past (near raw materials e.g. Leeds near coal). Counter-urbanisation is a recent trend.

8. Location and importance of Bristol

Location	South west of the UK, on Bristol Channel. Near to junction of M4 & M5.
Importance within the UK	Largest city in the southwest. 8 th most popular city for foreign tourists. 2 universities and 2 cathedrals.
Importance to wider world	Largest concentration of silicon chip manufacturing outside of California. International airport (links to Europe). Many TNCs located there (AirBus, BMW)

9. Impacts of migration on the growth and character of the city

National migration	1851 - 1891 population doubled as people arrived looking for work.
International migration	Now international migration accounts for half of its growth. 50 countries. Many from Europe (Poland, Spain).
Impact on	Many cultural opportunities. Afro-Caribbean- strong community

10. Urban change in Bristol

- Population is growing rapidly.
- Population is more ethnically diverse.
- More under 16-year olds than of pensionable age.
- Electrification of railway to London (<70 minutes).
- Become more accessible (road, rail, air).

11. Opportunities created by urban change

Cultural mix	50 countries represented (food, art). St Paul's Carnival (attracts 40,000).
Recreation and entertainment	Underground music scene -Colston Hall. Entertainment (The Bristol Old Vic). 2 football teams (City, Rovers). Shopping Cribbs Causeway, Cabot Circus.
Employment	Highly tech. industries = jobs. 50 silicon businesses. Many TNCs. £100 million improved broadband.
Integrated transport system	Links different types of public transport Reduces congestion in the city. ↗ % people walking and cycling (57%).
Urban greening	> 90% live within 350m of park/water. 300 parks. 1/3 Bristol is open space. 2015 European Green Capital status.

12. An example of an urban regeneration project

Example	Why did it need regeneration?	What are the main features?	Successful?
Temple Quarter, Bristol	<ul style="list-style-type: none"> • Bristol surrounded by a green belt. • Brownfield site- rundown, ugly. • By Bristol Temple Meads Station- poor impression for new visitors. • Previously an industrial area. 	<ul style="list-style-type: none"> • Enterprise Zone e.g. low rents. • Improve access e.g. ITS. • New bridge across River Avon (access to planned Bristol Arena). • Maintain historical features, cobbled streets- gives character • Brunel's Engine Shed £1.7mill. 	<ul style="list-style-type: none"> ✓ 4,000 new jobs by 2020 (17,000 by 2037) ✓ Attracts tourists. ✓ Redeveloped brownfield site ✗ Arena still not built

13. Challenges created by urban change

Urban deprivation	Some areas face social deprivation. 1/3 of people in Filwood are in very-low income households. Problems of crime, drug use, low quality housing, lack of transport.
Inequality in housing	Filwood- 50% in council housing. Stoke Bishop- millionaires (large villas)
Inequality in education	Filwood- 36% get top GCSE grades. Stoke Bishop- 94%.
Inequality in health	Filwood- Life expectancy 78 years. Stoke Bishop- 83 years.
Employment	Filwood- 1/3 16-24-year olds. Stoke Bishop- Just 3%.
Dereliction	Industrial buildings derelict (inner-city). Stokes Croft (many squatters).
Building on brown and greenfield	2006-13 94% housing on brownfield. Plan for 30,000 homes on brownfield. Temple Meads built on brownfield.
Waste disposal	>1/2 million tonnes of waste/year. (23% lower per head than UK average) ↗ recycling by 50%. Teach it in schools.
Urban sprawl	Greenbelt to prevent merge with Bath City extended to NW (Bradley Stoke). Led to destruction of greenfield sites. Yate- Commuter settlement.



1. Global pattern of urban change

The world's population is growing rapidly; currently 50% of us live in urban areas.

Urbanisation	
HICs	
NEEs	
LICs	

2. Factors affecting urbanisation

Rural-Urban migration	
Push factors	
Pull factors	
Natural Increase	

3. Megacities

Megacity	
How many?	
Where?	

4. Key terms

Social deprivation	
Dereliction	
Urban Greening	
Urban sprawl	
Integrated Transport System	
Brownfield	
Greenfield	
Commuter settlements	

5. Sustainable urban living

Sustainable urban living	
Water conservation	
Energy conservation	
Waste recycling	
Creating green space	

6. Urban transport strategies used to reduce traffic congestion

Problems with congestion	
Beryl Bikes	
Oyster Cards	
Park and ride	
Congestion charge	
Bus lanes	



7. Distribution of population and major cities in the UK

Population	
Cities	

8. Location and importance of Bristol

Location	
Importance within the UK	
Importance to wider world	

9. Impacts of migration on the growth and character of the city

National migration	
International migration	
Impact on character	

10. Urban change in Bristol

--

11. Opportunities created by urban change

Cultural mix	
Recreation and entertainment	
Employment	
Integrated transport system	
Urban greening	

12. An example of an urban regeneration project

Example	Why did it need regeneration?	What are the main features?	Successful?
Temple Quarter, Bristol			

13. Challenges created by urban change

Urban deprivation	
Inequality in housing	
Inequality in education	
Inequality in health	
Employment	
Dereliction	
Building on brown and greenfield	
Waste disposal	
Urban sprawl	

Year 10 OCR A Term 1 –Landscapes of the UK



Background:	
1.	The physical landscapes of the UK have distinctive characteristics. The characteristics are caused by changes in Geology, Climate and Land Use (A).
2.	There are a number of geomorphic processes which create distinctive landscapes (B, C, D)
3.	Rivers create a range of landforms which change with distance from their source within a river basin (E).
4.	There are a range of landforms within the coastal landscape (G, H, I & J)
5.	Landscapes are dynamic and differ depending on their geology, climate and human activity (F & K)

A.	UK Distinctive Landscapes
Mountainous / Upland Area	<ul style="list-style-type: none"> Over 600m in height. Unevenly distributed across the UK, Located in Northern Ireland, Scotland & Wales. Characteristics are mountainous, steep, rocky with low population. Geology = Igneous & Metamorphic Rock Climate is cool and wet.
Lowland Area	<ul style="list-style-type: none"> Between 0 and 200m above sea level. Evenly distributed across Southeast England. Characteristics are hills, wide rivers, flat land and farmland with high population. Geology = fertile soil over Sedimentary rock. Climate is mild with lower rainfall.
Glaciated Areas	<ul style="list-style-type: none"> Glaciers are slow moving flows of ice which carve large valleys into mountains. Unevenly distributed across UK Located in Northern Scotland./ Lake district. Characteristics are mountainous areas with U shaped valleys used for sheep farming & tourism. Geology = Igneous & Metamorphic Rock Climate is cool and wet.

B.	Geomorphic Processes
Geomorphic means a process that changes the landscape.	
Weathering	A Weathering is the breakdown of material in place (without being transported).
Mechanical weathering	Physical actions of rain, frost and wind that weaken the rock such as Onion Skin weathering and freeze thaw.
Chemical Weathering	Minerals in rocks reacting in different ways making them weaker such as Carbonic Acid dissolving limestone.
Biological	Plants and animals breaking rocks apart, such as roots growing in cracks or rabbits burrowing through soil.
Mass Movement	<p>The movement of soil and sediment down a slope by gravity.</p> <p>Sliding happens when a section of soil or rock moves suddenly down a slope.</p> <p>Slumping happens when a section of soil or rock moves gradually down a slope.</p>

C.	Erosion
Attrition	The 'knocking' of sediment against each other to become more rounded.
Hydraulic action	The sheer force of the water and air in cracks breaking down the riverbanks and bed.
Solution	The dissolving of minerals.
Abrasion	The action of sediment scraping against the bed and bank of the river (like sandpaper).

D.	Rivers - Transportation
Traction	Large rocks and boulders that are too heavy to pick up are ROLLED along the river bed.
Saltation	Medium size rocks are BOUNCED along the river bed.
Suspension	Small particles of sediment are CARRIED along by the river.
Solution	Minerals from the rock are DISSOLVED into the water.

E.	Rivers - Landforms
V Shaped Valley (Upper Course)	
<ul style="list-style-type: none"> When it rains, the water soaks into the sides of the valley making them unstable. Vertical erosion makes the valley sides even more unstable. They collapse into the river and are transported away. This leaves behind a v-shaped valley. 	
Waterfall (Upper Course)	
<ul style="list-style-type: none"> Occur when hard rock overlies soft rock. Soft rock erodes faster, undercutting the hard rock leaving a ledge. Eventually the unsupported ledge collapses and falls into the plunge pool. The process repeats and the waterfall retreats upstream, leaving behind a Gorge. 	
Meander (Middle / Lower Course)	
<ul style="list-style-type: none"> A meander is a bend in a river. Water flows faster around the outside of the bend eroding the riverbank and creating a River Cliff. Water flows slower around the inside of the bend, depositing sediment and creating a slip off slope. Meanders constantly change the floodplain making it flat. 	
Oxbow Lake (Middle / Lower Course)	
<ul style="list-style-type: none"> Form when the neck of a meander has been cut through by erosion. Water takes the quickest route. Deposition occurs sealing off the old meander, Over time sediment builds up completely cutting the Oxbow Lake off from the river. 	
Levee (Middle / Lower Course)	
<ul style="list-style-type: none"> Levees are made of large material which cannot travel as far. When a river floods, it slows down away from the channel. The larger material is deposited first either side of the river. When the flood water drains away, the large pieces of sediment are left behind. These form raised embankments either side of the river called levees. 	

Year 10 OCR A Term 1 – Landscapes of the UK



Background:	
1.	The physical landscapes of the UK have distinctive characteristics. The characteristics are caused by changes in Geology, Climate and Land Use (A).
2.	There are a number of geomorphic processes which create distinctive landscapes (B, C, D)
3.	Rivers create a range of landforms which change with distance from their source within a river basin (E).
4.	There are a range of landforms within the coastal landscape (G, H, I & J)
5.	Landscapes are dynamic and differ depending on their geology, climate and human activity (F & K)

A.	UK Distinctive Landscapes
Mountainous / Upland Area	<ul style="list-style-type: none"> Over _____ in height. _____ distributed across the UK, Located in _____, Sc _____ d & _____. Characteristics are _____s, v, r _____ with v population. Geology = I _____ & M _____ ic Rock Climate is _____.
Lowland Area	<ul style="list-style-type: none"> Between 0 _____ above sea level. Evenly distributed across _____ Characteristics are h _____ Geology = _____ S _____ y rock. Climate is _____.
Glaciated Areas	<ul style="list-style-type: none"> Glaciers are _____ Unevenly distributed _____ Located in _____./ Lake district. Characteristics are _____. Geology = _____ _____ Rock Climate is _____.

B.	Geomorphic Processes
Geomorphic means a process that changes the landscape.	
	A Weathering is the breakdown of material in place (without being transported).
	Physical actions of rain, frost and wind that weaken the rock such as Onion Skin weathering and freeze thaw.
	Minerals in rocks reacting in different ways making them weaker such as Carbonic Acid dissolving limestone.
	Plants and animals breaking rocks apart, such as roots growing in cracks or rabbits burrowing through soil.
	The movement of soil and sediment down a slope by gravity. Sliding happens when a section of soil or rock moves suddenly down a slope. Slumping happens when a section of soil or rock moves gradually down a slope.

C.	Erosion
	The 'knocking' of sediment against each other to become more rounded.
	The sheer force of the water and air in cracks breaking down the riverbanks and bed.
	The dissolving of minerals.
	The action of sediment scraping against the bed and bank of the river (like sandpaper).

D.	Rivers - Transportation
	Large rocks and boulders that are too heavy to pick up are ROLLED along the river bed.
	Medium size rocks are BOUNCED along the river bed.
	Small particles of sediment are CARRIED along by the river.
	Minerals from the rock are DISSOLVED into the water.

E.	Rivers - Landforms
V Shaped Valley (Upper Course)	
<ul style="list-style-type: none"> When it rains, the water _____ making them u _____. _____ makes the valley sides _____ They collapse into _____ and are transported away. This leaves behind a _____. 	
Waterfall (Upper Course)	
<ul style="list-style-type: none"> Occur when _____ overlies _____. Soft rock _____, undercutting the _____ leaving a l _____ e. Eventually the u _____ ledge collapses and falls into the p _____ pool. The process repeats and the waterfall retreats upstream, leaving behind a _____. 	
Meander (Middle / Lower Course)	
<ul style="list-style-type: none"> A meander is a _____. Water flows f _____ around the outside of the bend eroding the riverbank and creating a _____. Water flows _____ around the inside of the bend, depositing s _____ t and creating a _____. Meanders constantly _____ 	
Oxbow Lake (Middle / Lower Course)	
<ul style="list-style-type: none"> Form when the neck of a meander _____ Water takes the _____. Deposition occurs sealing off the _____. Over time sediment builds up completely cutting the _____ from the river. 	
Levee (Middle / Lower Course)	
<ul style="list-style-type: none"> _____ are made of large material which cannot travel as far. When a river floods, _____ away from the channel. The larger material is deposited _____ When the flood water drains away, the large pieces of sediment are _____. These form raised e _____ either side of the river called _____s. 	

Year 10 OCR A Term 1 –Landscapes of the UK



Background:	
1.	The physical landscapes of the UK have distinctive characteristics. The characteristics are caused by changes in Geology, Climate and Land Use (A).
2.	There are a number of geomorphic processes which create distinctive landscapes (B, C, D)
3.	Rivers create a range of landforms which change with distance from their source within a river basin (E).
4.	There are a range of landforms within the coastal landscape (G, H, I & J)
5.	Landscapes are dynamic and differ depending on their geology, climate and human activity (F & K)

G.	Coast - Landforms
	<p>Headland</p> <ul style="list-style-type: none"> An area of resistant rock that sticks out into the sea. <p>Bay</p> <ul style="list-style-type: none"> An inlet along the coast where rock has been eroded away <p>Concordant coasts</p> <ul style="list-style-type: none"> A stretch of coastline that is made of the same rock type. <p>Discordant Coasts</p> <ul style="list-style-type: none"> A stretch of coastline that is made of different rock types, forming headlands and bays.

J.	Coasts – Depositional Landforms
	<p>Deposition is the dropping of sediment due to reduction in energy.</p> <p>Beaches</p> <ul style="list-style-type: none"> Beaches are formed by deposition. The sea loses energy due to friction with the seabed slowing down the wave. This causes the sea to drop sediment which forms a beach along the coastline. It can also be formed in sheltered bays where the land stops the wind and slows the waves down. Longshore drift moves sediment along a beach. <p>SPIT</p> <ul style="list-style-type: none"> A spit is a stretch of beach that projects out to sea. Longshore drift moves material along the coastline. A spit forms when the material is deposited due to change in direction of the coast. As the spit grows it will develop a hook if there is a secondary wind direction. Salt marshes form in the sheltered area behind the spit.

F.	Case Study - River Wye
Human Influence	<p>Craig Goch Dam</p> <ul style="list-style-type: none"> Provides flood protection downstream by regulating flow. Is a reservoir (it stores water for drinking) Made of impermeable rock. Some people think it is an eyesore. <p>Flood Warning</p> <ul style="list-style-type: none"> Soft engineering to alert people when flooding is likely. <p>River Straightening</p> <ul style="list-style-type: none"> River Lugg, a tributary to the Wye near Hereford was illegally straightened in 2020. River straightening speeds up flow and reducing flooding where it is straightened. It can cause flooding downstream and destroys habitats. <p>Floodplain Zoning</p> <ul style="list-style-type: none"> Land use on the lower course is restricted. Building houses on the floodplain is prohibited, as they would be damaged by flooding. Farming, sports fields and car parks are allowed on the floodplain around towns such as Hereford. <p>Industry</p> <ul style="list-style-type: none"> Industry grew near the River Wye as it provides raw materials (Iron and Stone) and was used for transport <p>Agriculture</p> <ul style="list-style-type: none"> The lower course is used for farming because it cannot be built on and is flat, fertile land. <p>Tourism</p> <ul style="list-style-type: none"> Tourists use the river for walking, canoeing, rock climbing and visit attractions such as Tintern Abbey.

H.	Coasts - Erosional Landforms
	<p>As headlands erode they form a sequence of distinctive landforms.</p> <p>Crack</p> <ul style="list-style-type: none"> The top of the headland is weathered, exposing an area of weakness that turns into a crack. <p>Cave</p> <ul style="list-style-type: none"> Abrasion and hydraulic action erode the crack making it wider and turning it into a cave. <p>Arch</p> <ul style="list-style-type: none"> Eventually the cave erodes through to the other side of the headland forming an arch. <p>Stack</p> <ul style="list-style-type: none"> The bottom of the arch is eroded making it wider, and top of the arch is weathered making it weaker. Eventually the arch will collapse leaving behind a pillar of rock called a stack. <p>Stump</p> <ul style="list-style-type: none"> The base of the stack is eroded by waves and collapses leaving a stump.

I.	Coasts - Transport
	<p>Longshore drift is a process of transportation that moves eroded material along the coastline.</p> <ol style="list-style-type: none"> The prevailing wind makes waves approach the coast at an angle. Swash carries sediment up the beach at an angle. Backwash carries sediment straight down the beach with gravity – at right angles to the beach. This creates a zig-zag movement of sediment along the beach.

K.	Case Study – Holderness Coast
Geology	Made of hard rock (Chalk) to the North and weak rock to the south (Boulder Clay). Has one of Europe's fastest eroding coastlines at 2m / year.
Human Influences	<p>Hard Engineering</p> <ul style="list-style-type: none"> Groynes act as barriers to stop longshore drift. Gabions stabilise the base of cliffs stopping landslips. Sea walls reflect wave energy back out to sea. <p>Soft Engineering</p> <ul style="list-style-type: none"> Beach nourishment is where sand is pumped back onto the beach. Beach reprofiling is the reshaping of a steep beach, usually after a storm event. Managed retreat means deciding that some areas cannot be protected and are left to be flooded by the sea.

Year 10 OCR A Term 1 –Landscapes of the UK



Background:	
1.	The physical landscapes of the UK have distinctive characteristics. The characteristics are caused by changes in Geology, Climate and Land Use (A).
2.	There are a number of geomorphic processes which create distinctive landscapes (B, C, D)
3.	Rivers create a range of landforms which change with distance from their source within a river basin (E).
4.	There are a range of landforms within the coastal landscape (G, H, I & J)
5.	Landscapes are dynamic and differ depending on their geology, climate and human activity (F & K)

G.	Coast - Landforms
	<p>Headland</p> <ul style="list-style-type: none"> An area of resistant rock that sticks out into the sea. <p>Bay</p> <ul style="list-style-type: none"> An inlet along the coast where rock has been eroded away <p>Concordant coasts</p> <ul style="list-style-type: none"> A stretch of coastline that is made of the same rock type. <p>Discordant Coasts</p> <ul style="list-style-type: none"> A stretch of coastline that is made of different rock types, forming headlands and bays.

J.	Coasts – Depositional Landforms
	<p>Deposition is the dropping of sediment due to reduction in energy.</p> <p>Beaches</p> <ul style="list-style-type: none"> Beaches are formed by deposition. The sea loses energy due to friction with the seabed slowing down the wave. This causes the sea to drop sediment which forms a beach along the coastline. It can also be formed in _____ where the land stops the wind and slows the waves down. Longshore drift moves sediment along a beach. <p>SPIT</p> <ul style="list-style-type: none"> A spit is a stretch _____ Longshore drift moves material _____. A spit forms when the material is _____ As the spit grows it will develop a _____ if there is a secondary wind direction. _____ form in the sheltered area behind the spit.

F.	Case Study - River Wye
Human Influences	<p>Craig Goch Dam</p> <ul style="list-style-type: none"> Provides _____ downstream by regulating _____ Is a reservoir (it stores water for drinking) Made of _____ Some people think _____. <p>Flood Warning</p> <ul style="list-style-type: none"> Soft engineering to alert people when flooding is likely. <p>River Straightening</p> <ul style="list-style-type: none"> River Lugg, a tributary to the _____ near H _____ was illegally straightened in 2020. River straightening _____ flow and reducing flood risk where it is straightened. It can cause flooding downstream and destroys _____ <p>Floodplain Zoning</p> <ul style="list-style-type: none"> Land use on the lower course is restricted. _____ on the floodplain is prohibited, as they would be damaged by _____. _____ are allowed on the floodplain around towns such as Hereford. <p>Industry</p> <ul style="list-style-type: none"> Iron and steel industry grew near the River Wye as it provides _____ (Iron and Stone) and was used for transport <p>Agriculture</p> <ul style="list-style-type: none"> The lower course is used for farming because it cannot be built on and is _____. <p>Tourism</p> <ul style="list-style-type: none"> Tourists use the river for _____ and visit attractions such as _____.

H.	Coasts - Erosional Landforms
	<p>As headlands erode they form a sequence of distinctive landforms.</p> <p>Crack</p> <ul style="list-style-type: none"> The top of the headland is weathered, exposing an area of weakness that turns into a _____ <p>Cave</p> <ul style="list-style-type: none"> _____ erode the crack making it wider and turning it into a cave. <p>Arch</p> <ul style="list-style-type: none"> Eventually the _____ erodes through to the other side of the _____ forming an arch. <p>Stack</p> <ul style="list-style-type: none"> The _____ is eroded making it _____, and top of the arch is weathered making it _____. Eventually the arch will collapse leaving behind a _____ <p>Stump</p> <ul style="list-style-type: none"> The base of the stack is eroded by _____ and collapses leaving a stump.

K.	Case Study – Holderness Coast
Geology	Made of hard rock (Chalk) to the North and weak rock to the south (Boulder Clay). Has one of Europe's fastest eroding coastlines at 2m / year.
Human Influences	<p>Hard Engineering</p> <ul style="list-style-type: none"> _____ act as barriers to stop longshore drift. _____ stabilise the base of cliffs stopping landslips. _____ reflect wave energy back out to sea. <p>Soft Engineering</p> <ul style="list-style-type: none"> Beach nourishment is where sand is pumped _____. Beach reprofiling is the _____ Managed retreat means deciding that some areas _____.

I.	Coasts - Transport
	<p>Longshore drift is a process of transportation that moves eroded material along the coastline.</p> <ol style="list-style-type: none"> The prevailing wind makes waves _____ Swash carries sediment _____. Backwash carries sediment _____. This creates a _____ of sediment along the beach.



Year 10 History : Medicine in Medieval England c1250-1500



What we are learning this term:
1.1 Ideas about the cause of disease and illness 1.2 Approaches to treatment and prevention 1.3 Dealing with the Black Death 1348-49

C.	Dealing with the Black Death
What is the Black Death?	<ul style="list-style-type: none"> Bubonic plague – outbreak in 1348-9 – 1/3rd to 1 / 2 of the population died in England. Caused by bacteria Yersinia pestis that was thought to have originated in China and came to Britain on fleas, on rats on ships.
Causes	<p>Miasma – bad air from the filthy conditions making you ill.</p> <p>Astrology – there was a weird alinement of Jupiter, mars and Saturn the previous year which was blamed for the plague</p> <p>Punishment from God- = People thought that society had become wicked so God had sent the plague to punish them.</p>

Treatments	Confesses sins and pray, bleeding and purging (but seemed to make worse), sweet herbs or fire to clean air.
Prevention	Pray and fast, leave the area, carry sweet herbs, quarantine (new people stay away for 40 days), clean streets (or don't, maybe bad smell will drive out miasma)

A.	Can you define these key words?
Miasma	Bad air that was believed to be filled with harmful fumes.
Quarantine	Separating the sick from the healthy to stop the spread of a disease.
Humours	The humours were four fluids that were thought to spread throughout the body and influence its health.
Purging	To get rid of anything unwanted.
Phlebotmey	The drawing of bloody by opening a vein.
Leprosy	a painful skin disease
Prevention	To stop something from happening
Treatment	giving medicine or using other means to help a person get better when sick or hurt
Apothecary	A person who mixes herbal remedies and treated patients as an alternative to a doctor as they were cheaper.
Barber surgeon	barbers and surgeons who also performed minor operations such as removal of warts .

Key People			
Hippocrates	Galen	Physicians, apothecaries and surgeons	Hospitals
<p>'Father of Medicine' – 4 humours, clinical observation (watch and record details, use this to help with future cases), importance of exercise, Hippocratic Oath for doctors (to preserve life)</p>	<p>Built on Hippocrates' ideas – theory of opposites (if cold, give something hot), also dissected animals to find out about anatomy (structure of body). Proved brain, not the heart, controls the body</p>	<ul style="list-style-type: none"> Physicians – diagnosed + recommended treatment, trained at university for around 7 years. Did not get to see dissections so new little about body. Learned everything from Galen's books. Only for super rich Apothecaries – mixed herbal remedies (joined a guild, worked for master to train). Surgeons – least qualified, also cut hair. Learned on job and only performed minor, on-invasive surgeries Monks and nuns – worked in hospitals mostly prayed for patients and gave comfort. Not allowed to cut or bleed patients so could not do surgery Housewives and mothers – treated most people. Mixed herbal remedies and treated minor wounds 	<ul style="list-style-type: none"> Ran by monks and nuns Offered patients shelter, beds, food and very limited treatment. Treatments mostly religious based – praying Patients would offer share beds which led to allot of diseases spreading around the hospitals

What were the causes of disease in Medieval England?		
Causes	Prevention	Treatments
<p>Religious – Punishment from God God has sent an illness as punishment for sins. Especially true at times of panic such as the Black Death.</p>	<p>Religious - Church – Lead a life free of sin.</p> <p>Regular prayers and confessions.</p> <p>Offering tithes to the church to make sure sins were forgiven quickly.</p>	<p>Religious – Healing prayers and incantations</p> <p>Paying for a special mass to be said</p> <p>Fasting</p> <p>Pilgrimages</p>
<p>Rational - Miasma – You had breathed in bad air. This was thought to come from swamps or rubbish. During this period there was allot of animal much in towns and often open sewers in the streets meaning the whole place stank. In these filthy places disease was more common seemingly proving this theory</p>	<p>Rational and religious - Regimen Sanitatis – A set of instructions provided by physicians to maintain good health.</p> <p>Bathing was also used to prevent miasma.</p>	<p>Supernatural - Astrology – Treatments varied according the the horoscope of the patient. The alignment of the planets was checked at every stage of the treatment prescribed eg herb gathering.</p>
<p>Rational - The Theory of the Four Humours – The 4 liquids in your body (blood, yellow bile, black bile, phlegm) were seen to be out of balance making you ill. Recovery came from getting them back in to balance through the theory of opposites Created in ancient Greece by Hippocrates.</p>	<p>Rational - Diet – Eating to much was strongly discouraged. What and when you ate were considered to be important in preventing a humoral imbalance.</p>	<p>Rational - Humoral Treatments – Blood letting – Bad humours could be removed from the body by removing some of the blood.</p> <p>Purging – Purging the digestive system to remove any leftover food. Eg using a laxative.</p>
<p>Supernatural - Astrology – Impact of the stars and planets on health. Physicians would use star charts to examine a patient and work out what was wrong with them.</p>	<p>Rational - Purifying the air –This was achieved by spreading sweet herbs.</p>	<p>Rational - Herbal remedies – Using herbal infusions to drink, sniff or bathe in.</p>



What we are learning this term:	
1.1 Ideas about the cause of disease and illness	
1.2 Approaches to treatment and prevention	
1.3 Dealing with the Black Death 1348-49	

C.	Dealing with the Black Death
What is the Black Death?	
Causes	
Treatments	
Prevention	

A.	Can you define these key words?
Miasma	
Quarantine	
Humours	
Purging	
Phlebotomy	
Leprosy	
Prevention	
Treatment	
Apothecary	
Barber surgeon	

Key People			
Hippocrates	Galen	Physicians, apothecaries and surgeons	Hospitals

What were the causes of disease in Medieval England?		
<u>Causes</u>	<u>Prevention</u>	<u>Treatments</u>



Keywords	
Tawhid	The belief in Islam that there is only one God who created everything
Omnipotent	God is all powerful and "has power over everything"
Immanent	God is active in the world and involved in its' creation.
Transcendent	God is outside of time and space. God cannot age or die or be located in one place.
Beneficent	Allah is compassionate, caring and good
Sunnah	The traditions and practices of the Prophet Muhammad
Qur'an	The Islamic sacred book
Hadith	A collection of traditions and sayings of the Prophet Muhammad
6 Articles of Faith	6 basic beliefs that shape the Islamic way of life
5 Roots of Usul Ad-Din	5 rules which explain how Muslims should act in daily life
Akhirah	Belief in the afterlife
Al Qadr	Supremacy of God's will and The belief in predestination which is slightly different for Sunni and Shi'a Muslims

What we are learning in this unit		
A. 6 Articles of Faith B. 5 Roots of Usul Ad-Din C. Sunnah and Hadith D. Risalah E. Torah, Psalms and Gospels F. Nature of Allah G. Qu'ran H. Torah, Psalms and Gospels I. Angels J. Al Qadir K. Day of Judgement, Paradise and Hell		

B. 5 Roots of Usul Ad-Din		
The 5 roots of Usul ad-Din are central to the Shi'a Muslim faith.		
Root	What is it?	Quote
1: Tawhid	The belief in the oneness of Allah	"He is God the One, God the eternal" Surah 112
2: Risalah	Belief in prophethood: the chain of messengers from Adam to Muhammad	"We sent messengers to every community" Surah 16
3: Adalat	Allah is just (fair) and will bring Divine Justice	"I advise you to being just towards both friend and foe" Imam Ali
4: Imamah	A term for God-given leadership	"obey God and the Messenger, and those in authority among you"
5: Mi'ad	The day of judgement and resurrection	"His is the judgement; and to Hjm you shall be returned"

A. 6 Articles of Faith	
Article of faith	What is it?
1: Belief in one God	Allah is the creator and sustainer of life. There is no God but Allah
2: Belief in Angels	Angels do the work of Allah and do not have free will like humans. They obey Allah
3: Belief in God's revealed books	The Torah, the Psalms, the Gospels, the Scrolls of Abraham and the Qur'an.
4: Belief in the messengers of God	Prophets and messengers are chosen by Allah to deliver His message to humankind
5: Belief in the Day of Judgement	There will be a day when all people stand in front of Allah and are sent to Heaven or Hell
6: Belief in pre-destination	Allah knows everything. Everything is ordered by Allah – nothing is random or by chance

C. Sunnah and Hadith	
Sunnah	<ul style="list-style-type: none"> The practices, customs and traditions of Prophet Muhammad They give an example for Muslims to follow The Sunnah and Hadith are sources of Wisdom and authority alongside the Qur'an
Hadith	<ul style="list-style-type: none"> Reading the Hadith helps a Muslim to learn how Muhammad explained the teachings from the Qur'an The Hadith makes the Qur'an easier to understand
What does the Sunnah tell Muslims?	<ul style="list-style-type: none"> The Sunnah covers many areas of life It provides a guideline for Muslim life There is a Sunnah for everything



Keywords	
Tawhid	
Omnipotent	
Immanent	
Transcendent	
Beneficent	
Sunnah	
Qur'an	
Hadith	
6 Articles of Faith	
5 Roots of Usul Ad-Din	
Akhirah	
Al Qadr	

What we are learning in this unit		
A. 6 Articles of Faith B. 5 Roots of Usul Ad-Din C. Sunnah and Hadith D. Risalah E. Muhammad F. Nature of Allah G. Qu'ran H. Torah, Psalms and Gospels I. Angels J. Al Qadir K. Day of Judgement, Paradise and Hell		

B.	<i>5 Roots of Usul Ad-Din</i>
-----------	-------------------------------

Root	What is it?	Quote
1:		
2:		
3:		
4:		
5:		

A.	6 Articles of Faith	
Article of faith	What is it?	
1:		
2:		
3:		
4:		
5:		
6:		

C.	Sunnah and Hadith	



D.	<i>Risalah (Prophethood)</i>	E	<i>Torah, Psalms and Gospels</i>
What is it	<ul style="list-style-type: none"> • Muslims believe there has been 124,000 prophets • Every Islamic prophet preached Islam and key beliefs • The first was Adam, the last was Muhammad (Box E) 	Psalms (Zabur)	<ul style="list-style-type: none"> • The Psalms of Dawud are a collection of prayers to Allah • They contain lessons of guidance for the people
Why are prophets important?	<ul style="list-style-type: none"> • Prophets are guided by Allah • Their love of Allah stops them from sinning • Some prophets are messengers who have been given revelation of news 	Gospel (Injil)	<ul style="list-style-type: none"> • This is the good news about Isa (Jesus) • Muslims highly respect Isa because there are revelations in the Qur'an about him • Muslims believe he was the Masih, he was not the son of Allah, he was not crucified, he did not die to save sins • The gospels contain some mistakes because they were written many years after Isa died
Adam	<ul style="list-style-type: none"> • The first prophet • The father of all humankind • He taught about the work of Iblis and how to protect themselves • He taught life on Earth was temporary, eternal life is in the next life • He built the Ka'aba as the first place of worship 	Torah (Tawrat)	<ul style="list-style-type: none"> • The Tawrat is the Arabic word for the Torah • These are the revelations given to Moses by Allah on Mt Sinai • The Qur'an refers to the Tawrat as "guidance and light"
Ibrahim	<ul style="list-style-type: none"> • Ibrahim was told in a dream to sacrifice Isma'il as a test of faith – remembered at Hajj every year • His son Isma'il is the ancestor of the prophet Muhammad 	Scrolls of Ibrahim	<ul style="list-style-type: none"> • Revelations received by Ibrahim on the first day of Ramadan • Contained stories about worship and reflection • Not a book, individual revelations

F.	<i>The Nature of Allah</i>
Tawhid	<ul style="list-style-type: none"> • There is only one God and this God has no equal. • He created everything. • Only He should be worshipped: worshipping other Gods is a sin called shirk. • "There is no God but Allah, and Muhammad is his messenger". • "Allah witnesses that there is no deity except Him" • "Do they not see that Allah, who created the heavens and the Earth and was not wearied by their creation, has the power to raise the dead to life?"
2: Omnipotent	Allah is all powerful and has power over everything
3: Immanence	Allah is active in the world and able to control events
4: Transcendent	<ul style="list-style-type: none"> • Allah is outside of the universe • Not limited by time or space
5: Beneficence	God has love and good will
6: Mercy	<ul style="list-style-type: none"> • "In the name of Allah, the most compassionate, the most merciful" • God is forgiving and caring
7: Fairness and justice	<ul style="list-style-type: none"> • Allah is fair to all people • Allah has sent the same message to all prophets to allow humans numerous opportunities to submit to the will of Allah • Allah will ensure that judgement is fair and punishments are suitable



D.	<i>Risalah (Prophethood)</i>	E	<i>Torah, Psalms and Gospels</i>
What is it		Psalms (Zabur)	
Why are prophets important?		Gospel (Injil)	
Adam		Torah (Tawrat)	
Ibrahim		Scrolls of Ibrahim	

F.	<i>The Nature of Allah</i>
Tawhid	
2: Omnipotent	
3: Immanence	
4: Transcendent	
5: Beneficence	
6: Mercy	
7: Fairness and justice	



G.	<i>Qur'an</i>	I.	<i>Angels</i>
Revelation	<ul style="list-style-type: none"> Chapters of the Qur'an were revealed to Prophet Muhammad over 13 years in Makkah While Muhammad received the revelations, he was not able to change them because it was the will of Allah After Muhammad received them, he recited them, and somebody wrote them down. 	What are they?	<ul style="list-style-type: none"> Angels are made from light and have wings which can move at the speed of light They have no gender and are in the unseen world They always complete what Allah asks and they always obey Allah as they have no free will
Authority	<ul style="list-style-type: none"> It is the direct word of Allah so it has His authority It is without error and remains in its' original form A written book was needed to formalise the religion 	What do they do?	<ul style="list-style-type: none"> Watch over humans Bring peace to believers and instill fear in non-believers Angel of Death takes the soul at death Greet people entering paradise or throw people into the pits of hell Signify the end of the world by blowing a horn
What does it contain?	<ul style="list-style-type: none"> It covered every aspect of life It influences a person throughout their lives The basics of worship which Muhammad developed Shari'ah law and social systems It explains creations and other ultimate questions 	Jibril	<ul style="list-style-type: none"> Most important angel in Islam Always brings good news Helped Ibrahim when he was thrown in to a fire, opened up the Zamzam well for Hajar Told Maryam she would have a son (Isa) Dictated the Qur'an directly from Allah
Supreme authority	<ul style="list-style-type: none"> The Qur'an is believed to have supreme authority It is a timeless book – it is only the word of Allah if it is not translated from Arabic 	Mika'il	<ul style="list-style-type: none"> Assisted Muhammad with his spiritual mission Giver of rain and sustenance – in charge of plants and rain Helped Muhammad to fight for Makkah Will help to weigh peoples' actions on Judgement Day Mika'il prepared Muhammad by providing Jibril with purifying water

K.	<i>Day of Judgement, paradise and Hell</i>
What will happen?	<ul style="list-style-type: none"> Muslims believe Judgement day will come on a Friday (Adam was created on a Friday) It will be announced by Israfil's trumpet Allah will refer us to the book of deeds to justify damnation or salvation Humans will go to paradise or Hell
Jannah	<ul style="list-style-type: none"> Paradise No growing ill, old or dying – it is a reward and gift from Allah A person must live religiously and ask Allah for forgiveness Good beliefs and actions It is beyond human imagination
Entry to Jannah	<ul style="list-style-type: none"> "enter among my servants! Enter my paradise!" People will arrive over the As-Sirat bridge There are 8 gates and you go through the one which represents your best action Two angels welcome people saying "peace be upon you"
Jahannam	<ul style="list-style-type: none"> Hell People wail in misery, 70x hotter than any flame on earth, boiling water poured on their heads, pain, dragged in chains Punishment for a life full of evil or rejecting the teachings of the Qur'an

J.	<i>Al Qadir</i>
	<ul style="list-style-type: none"> Everything happens as a result of Allah's will and nothing is ever random or without reason Allah is in charge of everything Everything is a part of Allah's plan "never will we be struck except by what Allah has decreed for us"
E.	<i>Muhammad</i>
Why was he chosen?	<ul style="list-style-type: none"> Muhammad had characteristics such as responsibility, determination, patience, courage and honesty He was highly respected in his community He was extremely devoted to Allah – he prayed and fasted for long periods of time
What did he do as a prophet?	<ul style="list-style-type: none"> He became the ruler of Madinah and set up the first Islamic community He converted the people of Makkah to Islam
Why is Muhammad important?	<ul style="list-style-type: none"> He is seen as the perfect role model as he is trustworthy and obedient to Allah His influence can still be seen in the Hadith and Sunnah The night of power in Ramadan is to remember Muhammad's first revelation from the angel Jibril



G.	<i>Qur'an</i>	I.	<i>Angels</i>
Revelation		What are they?	
Authority		What do they do?	
What does it contain?		Jibril	
Supreme authority		Mika'il	

K.	<i>Day of Judgement, paradise and Hell</i>	J.	<i>Al Qadir</i>
What will happen?			
Jannah		E.	<i>Muhammad</i>
Entry to Jannah		Why was he chosen?	
Jahannam		What did he do as a prophet?	
		Why is Muhammad important?	

GCSE Unit 5 SPANISH Knowledge organiser.
Topic Home, Town, Neighbourhood and Region

Key Verbs

What we are learning this term:

A. Saying what your house is like
 B. Describing your house and where it is
 C. Talking about the amenities in your area
 D. Discussing the advantages and disadvantages of living in the town and country

5.2G ¿Qué se puede hacer donde vives?

el barrio neighbourhood, area
 la biblioteca library
 la bolera bowling alley
 el bolso handbag
 la carnicería butcher's
 el césped lawn
 el collar necklace
 descansar to rest
 el dinero money
 divertirse to enjoy oneself, to have a good time
 el estanco tobacconist's (also sells stamps)
 los grandes almacenes department stores
 la joyería jeweller's
 la juguetería toy shop
 el mercado market
 la muñeca doll
 el museo museum
 la panadería baker's
 el parque infantil park, playground
 la pastelería cake shop
 los pendientes earrings
 la plaza de toros bull ring
 la ropa (de marca) (designer) clothes
 la tienda de comestibles grocery store, food

Vivir To live	alquilar To rent	Comprar To buy	Hacer – to do/make	Mudarse To move
Vivo I live	Alquilo I rent	Compro I buy	Hago I do	Me mudo I move
Vives You live	Alquilas You rent	Compras You buy	Haces You do	Te mudas You move
Vive He/she lives	Alquila He/she rents	Compra He/she buys	Hace s/he does	Se muda He/she moves
Vivimos We live	Alquilamos We rent	Compramos We buy	Hacemos We do	Nos mudamos We move
Viven They live	Alquilan They rent	Compran They buy	Hacen They do	Se mudan They move

6 Key Words for this term

1. vivir	4. el hogar
2. alojamiento	5. la casa
3. alquilar	6. las afueras

5.1G Mi casa

la alfombra carpet, rug
 el armario cupboard, wardrobe
 el ascensor lift
 la butaca armchair
 la cocina kitchen, cooker, cuisine
 cómodo comfortable, convenient, handy
 compartir to share
 el cuarto de baño bathroom
 el dormitorio bedroom
 los electrodomésticos (electrical) appliances
 la escalera stairs
 el espejo mirror
 la estantería shelves, shelving unit
 el fregadero kitchen sink
 la habitación room
 el lavabo washbasin
 la lavadora washing machine
 el lavaplatos dishwasher
 el microondas microwave oven
 la nevera fridge
 la pared wall
 el salón lounge, living room
 el sillón armchair
 el suelo ground, floor

5.2F Mi ciudad

la avenida avenue
 el ayuntamiento Town Hall
 bienvenido/a welcome
 el centro comercial shopping centre
 la ciudad city, large town
 el club de jóvenes youth club
 Correos Post Office
 construir to build
 convertirse en (+ noun) to become
 los espacios verdes open spaces
 la fábrica factory
 fundar to found
 el/la habitante inhabitant
 la iglesia church
 ir de compras to go shopping
 el país country
 la plaza square (in a town)
 el polideportivo sports centre
 el pueblo (small) town, village, people
 el puente bridge
 el puerto port, harbour
 el siglo century

5.1H Mi casa y mi barrio

abajo under, downstairs
 amplio/a spacious, roomy
 arriba above, upstairs, up
 el balcón balcony
 la calefacción heating
 la cocina amueblada fitted kitchen
 el comedor dining room
 el comercio business, shop
 imprescindible essential, indispensable
 inferior lower
 el jardín garden
 lujoso/a luxurious
 la mascota pet
 la piscina swimming pool
 la planta floor (of a building), plant
 la planta baja ground floor
 superior upper, higher
 la tienda shop
 la torre tower, tower block
 la vista view, sight

5.1F ¿Cómo es tu casa?

las afueras outskirts
 antiguo old
 el árbol tree
 el campo countryside,
 field,sports ground
 el chalet / chalé bungalow, detached
 house, villa
 la costa coast
 el estante shelf
 encontrar to find
 encontrarse to be situated
 encontrarse con to meet up with
 la granja farm
 guardar to keep, to put
 away,to save
 la librería bookcase, bookshop
 la montaña mountain
 el mueble piece of furniture
 los muebles furniture
 peor worse

GCSE Unit 5 SPANISH Knowledge organiser.
Topic Home, Town, Neighbourhood and Region

Key Verbs				
To live	alquilar	Comprar To _____	Hacer – _____	Mudarse To _____
Vivo	Alquilo	Compro	Hago I do	Me mudo
You live	You rent	Compras	You do	You move
Vive	Alquila	Compra He/she buys	Hace	Se muda
We live	We rent	Compramos	Hacemos	Nos mudamos
They live	They rent	They buy	They do	They move

What we are learning this term:	
A. Saying what your house is like B. Describing your house and where it is C. Talking about the amenities in your area D. Discussing the advantages and disadvantages of living in the town and country	
6 Key Words for this term	
1. vivir	4. el hogar
2. alojamiento	5. la casa
3. alquilar	6. las afueras

5.2G ¿Qué se puede hacer donde vives?	
el _____	neighbourhood, area
la biblioteca	_____
la _____	bowling alley
el _____	handbag
la carnicería	_____
el _____	lawn
_____	necklace
descansar	_____
_____	money
_____	to enjoy oneself, to
have a good time	_____
el _____	tobacconist's (also sells stamps)
los grandes almacenes	_____
la joyería	_____
la _____	toy shop
el mercado	_____
_____	doll
el _____	museum
la panadería	_____
_____	infantil park, playground
la _____	cake shop
los pendientes	_____
la plaza de toros	_____
la ropa (de marca)	_____
la tienda de comestibles	_____

5.1H Mi casa y mi barrio	
_____	under, downstairs
_____	spacious, roomy
_____	above, upstairs, up
el balcón	_____
la calefacción	_____
la cocina amueblada	_____
el _____	dining room
el _____	business, shop
_____	essential, indispensable
inferior	_____
el jardín	_____
lujoso/a	_____
_____	pet
_____	swimming pool
_____	floor (of a building), plant
la planta baja	_____
superior	_____
la _____	shop
la _____	tower, tower block
la _____	view, sight

5.1F ¿Cómo es tu casa?	
_____	outskirts
antiguo	_____
el _____	tree
el campo	countryside
field,sports ground	_____
el chalet / chalé	_____ house, villa
la costa	_____
el _____	shelf
_____	to find
_____	to be situated
_____	to meet up with
la granja	_____
_____	to keep, to put
away,to save	_____
la _____	bookcase, bookshop
la _____	mountain
el mueble	_____
los _____	furniture
peor	_____

5.1G Mi casa	
la alfombra	_____
el armario	_____
el ascensor	_____
_____	armchair
la _____	kitchen, cooker, cuisine
_____	comfortable, convenient, handy
compartir	_____
el cuarto de baño	_____
el dormitorio	_____
los _____	(electrical) appliances
la _____	stairs
el espejo	_____
la _____	shelves, shelving unit
el fregadero	_____
la habitación	_____
_____	washbasin
_____	washing machine
el lavaplatos	_____
el microondas	_____
la _____	fridge
la pared	_____
el salón	_____
el _____	armchair
el _____	ground, floor

5.2F Mi ciudad	
la avenida	_____
el ayuntamiento	_____
bienvenido/a	_____
_____	shopping centre
_____	city, large town
el club de jóvenes	_____
Correos	_____
construir	_____
convertirse en (+ noun)	_____
los _____	open spaces
la _____	factory
_____	to found
el/la habitante	_____
la iglesia	_____
_____	to go shopping
_____	country
la _____	square (in a town)
el _____	sports centre
el pueblo (small)	_____
el puente	_____
_____	port, harbour
el siglo	_____

What we are learning this term:

A. Talking about different ways of volunteering
 B. Talking about charities and voluntary work
 C. Talking about healthy eating
 D. Talking about healthy and unhealthy lifestyles
 E. Listening for different tenses

6 Key Words for this term

1. un voluntario/a	4. comedor social
2. ecologista	5. banco de alimentos
3. los sin techo	6. quiero

6.1G ¿Quieres ser voluntario/a?

arreglar	to tidy, to fix, to arrange
ayudar (a)	to help (to)
el banco de alimentos	food bank
charlar	to chat
el comedor social	soup kitchen
el concurso	competition
cultivar	to grow, cultivate
disfrutar	to enjoy
ecologista	environmental
la gente mayor	old people
hogar	home
limpiar	to clean
marcar (un gol)	to score (a goal)
necesitado	needed, required
los necesitados	the needy
la organización benéfica	charitable organisation, charity
participar (en)	to take part (in)
pasarlo bien	to have a good time
proteger	to protect
la residencia de ancianos	old people's home
los "sin techo"	the homeless
el Tercer Mundo	the Third World
la tienda con fines benéficos	charity shop
/tienda solidaria	
el/la voluntario/a	volunteer

6.1F Me gustaría ayudar

agradecer	to thank
aprender	to learn
el asombro	amazement, surprise
contar (que)	to tell, to relate
el curso	school year, course
los/las demás	the others, the rest
esperar	to wait for, to hope, to expect
formar parte	to be part (of)
hacer la cama	to make the bed
el centro de menores	children's home
tutelados	
el idioma	language
inútil	useless
propósito	aim, purpose, objective
repartir	to deliver, to hand out
tener sueño	to be sleepy
la tienda solidaria	charity shop
útil	useful

6.2G ¿Comes bien?

acostarse	to go to bed
las bebidas alcohólicas	alcoholic drinks
las bebidas azucaradas	sugary drinks
borracho/a	drunk
el dolor	pain, ache
emborracharse	to get drunk
evitar	to avoid
glotón	greedy
la grasa	fat
grasiento/a	fatty, greasy
intentar (+ infinitive)	to try to
el ladrón	thief, robber
malsano	unhealthy
musulmán	Muslim
poco sano	not healthy
la ración	portion
saludable	healthy
sano	healthy

Ayudar To help	Ir To go	Soportar To stand	Hacer – to do/make	Limpiar To clean
Ayudo I help	Voy I go	Soporto I can stand	Hago I do	Limpio I clean
Ayudas You help	Vas You go	Soportas You can stand	Haces You do	Limpias You clean
Ayuda He/she helps	Va s/he goes	Soporta He/she can stand	Hace s/he does	Limpia He/she cleans
Ayudamos We help	Vamos They go	Soportamos W can stand	Hacemos We do	Limpiamos We clean
Ayudan They help	Van They go	Soportan They can stand	Hacen They do	Limpian They clean

6.1H La importancia de obras benéficas

andar	to walk
el bolsillo	pocket
contribuir	to contribute
dar asco	to nauseate
el dibujo	drawing
donar	to donate
en vías de extinción	threatened (threatened with extinction)
escaso/a	scarce
la exposición	exhibition
el ganador	winner
ganar	to win
gastar	to spend
las instalaciones	facilities
el medio ambiente	environment
las obras benéficas	charity, charitable works
la pérdida	loss
perteneciente a	belonging to
el/la político/a	politician
los recursos	resources
seropositivo/a	HIV positive
el sida	AIDS
temer	to fear

6.2H ¿Qué opinas?

aguantar	to put up with, to bear
asqueroso/a	disgusting
ataque cardíaco	heart attack
aumentar	to increase
el botellón	drinking party in the street
cada vez más	more and more
el cerebro	brain
el consumo	consumption
el corazón	heart
cuanto antes	as soon as possible
el/la drogadicto/a	drug addict
la edad	age
la encuesta	survey
enfrentar	to face
grave	serious
hacer daño a	to injure, to harm
el hígado	liver
nocivo/a	harmful
participar (en)	to take part (in)
pedir	to ask (for), to ask (someone to do something)
los primeros auxilios	first aid
prohibir	to prohibit, to forbid
provocar	to cause, to provoke
el pulmón	lung
reducir	to reduce
síndrome de abstinencia	withdrawal symptoms
el sobrepeso	excess weight, obesity
subir	to go up
el tabaquismo	addiction to tobacco
la venta	sale

GCSE Unit 6 SPANISH KEEPER organiser.
Topic Social Issues

What we are learning this term:

A. Talking about different ways of volunteering
 B. Talking about charities and voluntary work
 C. Talking about healthy eating
 D. Talking about healthy and unhealthy lifestyles
 E. Listening for different tenses

- 6 Key Words for this term**
- | | |
|--------------------|-----------------------|
| 1. un voluntario/a | 4. comedor social |
| 2. ecologista | 5. banco de alimentos |
| 3. los sin techo | 6. quiero |

6.1G ¿Quieres ser voluntario/a?

_____ to tidy, to fix, to arrange
 _____ to help (to)
 el banco de alimentos _____
 charlar _____
 el comedor social _____
 _____ competition
 _____ to grow, cultivate
 disfrutar _____
 ecologista _____
 _____ old people
 _____ home
 limpiar _____
 marcar (un gol) _____
 _____ needed, required
 los necesitados _____
 la organización benéfica _____
 participar (en) _____
 _____ to have a good time
 proteger _____
 la residencia de ancianos _____

 el Tercer Mundo _____
 la tienda con fines benéficos _____
 /tienda solidaria _____
 el/la voluntario/a _____

6.1F Me gustaría ayudar

agradecer _____
 _____ to learn
 el asombro _____
 _____ to tell, to relate
 _____ school year, course
 los/las demás _____
 _____ to wait for, to hope, to
 expect _____
 formar parte _____
 hacer la cama _____
 el centro de menores _____
 tutelados _____
 _____ language
 _____ useless
 _____ aim, purpose, objective
 repartir _____
 _____ to be sleepy
 la tienda solidaria _____
 útil _____

6.2G ¿Comes bien?

acostarse _____
 las bebidas alcohólicas _____
 las bebidas azucaradas _____
 _____ drunk
 _____ pain, ache
 _____ to get drunk
 evitar _____
 glotón _____
 la grasa _____
 _____ fatty, greasy
 intentar (+ infinitive) _____
 el ladrón _____
 _____ unhealthy
 musulmán _____
 _____ not healthy
 la _____ portion
 saludable _____
 _____ healthy

Key Verbs				
To help	Ir _____	Soportar To stand	Hacer – _____	Limpiar To clean
Ayudo I _____	Voy I go	_____ I can stand	Hago _____	_____ I clean
_____ You help	Vas _____	Soportas _____	Haces You do	Limpias _____
Ayuda _____	_____ s/he goes	Soporta He/she can stand	_____ s/he does	_____ He/she cleans
Ayudamos We help	Vamos _____	Soportamos W can stand	Hacemos _____	Limpiamos _____
_____ They help	They go	_____ They can stand	_____ They do	Limpian They clean

6.1H La importancia de hacer obras benéficas

andar _____ to _____
 el _____ pocket
 contribuir _____ to _____
 _____ to nauseate
 el dibujo _____
 donar _____ to _____
 en _____ threatened (threatened
 with extinction)
 escaso/a _____
 la _____ exhibition
 el _____ winner
 ganar _____ to _____
 gastar _____ to _____
 las _____ facilities
 el medio ambiente _____
 las _____ charity, charitable works
 la pérdida _____
 perteneciente a _____
 _____ politician
 _____ resources
 seropositivo/a _____
 _____ AIDS
 temer _____

6.2H ¿Qué opinas?

_____ to put up with, to bear
 asqueroso/a _____
 ataque cardíaco _____
 aumentar _____ to _____
 el _____ drinking party in the
 street
 cada vez más _____
 el _____ brain
 el _____ consumption
 el corazón _____
 _____ as soon as possible
 el/la drogadicto/a _____
 la _____ age
 la _____ survey
 enfrentar _____ to _____
 _____ serious
 _____ to injure, to harm
 el hígado _____
 nocivo/a _____
 _____ to take part (in)
 _____ to ask (for), to ask
 (someone to do something)
 los primeros auxilios _____
 _____ to prohibit, to forbid
 _____ to cause, to provoke
 el pulmón _____
 reducir _____ to _____
 síndrome de abstinencia _____ withdrawal symptoms
 el _____ excess weight,
 obesity
 subir _____
 el _____ addiction to tobacco
 la venta _____



Term	Definition
Abstraction	The process of removing all unnecessary details from a problem.
Algorithm	The sequence of steps required to carry out a specific task.
Assignment	Setting the value of a variable in a computer program.
Data	Units of information which is acted upon by instructions.
Decomposition	Breaking down a problem into smaller steps that are easier to work with and solve.
Flowchart	A diagram which shows the step by step flow of an algorithm.
Input	Data which is inserted into a system to be processed or stored.
Output	Data which is sent out of a system.
Process	An action taken by the program without input from the user.
Pseudocode	A method of writing an algorithm using plain English.
Variable	A memory location within a computer where values are stored

Data Type	Explanation	Example
Boolean	TRUE/FALSE or 1/0	TRUE or 1
Character	A single, alphanumeric character.	1 or A or !
Integer	Whole numbers	15
String	One or more alphanumeric characters.	1A!
Real - Float	Decimal numbers	15.5

Flowchart Symbol	Name	Usage
Start/Stop	Terminator	The start or end of the algorithm.
Process	Process	An action which occurs during the algorithm.
Input/Output	Input/Output	Data is either inputted to or outputted from the algorithm.
Decision	Decision	A Yes/No, True/False decision.

Common Algorithms	Explained
Binary Search	Compares the search object to the middle point of a sorted list. If they are not equal, the half in which the target cannot lie is eliminated and the search continues on the remaining half, again taking the middle point to compare to the search object, and repeating this until the target value is found or the end is reached.
Bubble Sort	Sorts a list by continuously stepping through a list, swapping items until they appear in the correct order.
Linear Search	Compares the search object with each item in the list in order from the beginning until it is found or the end is reached.
Merge Sort	Sorts a list by repeatedly dividing a list into two until all the elements are separated individually. Pairs of elements are then compared, placed into order and combined. The process is then repeated until the list is recompiled in the correct order as a whole.

Term	Definition
Arithmetic Operator	A mathematical character to perform a calculation. Example: +
Array	A set of values, of the same data type, stored in sequence. A list.
Casting	Setting or changing the data type of a variable.
Concatenation	Connecting strings of characters together.
Condition	A statement which is either true or false. A computation depends on whether a condition is true or false.
Constant	A value which does not change whilst the program is running.
Element	An individual item in an array. A value in a list.
File	Anything you can save. Document, piece of music, data etc.
Identifier	A name, usually for part of the program such as a constant, variable, array etc.
IF Statement -Selection	A statement that lets a program select an action depending on whether it is true or false.
Loops -Iteration	Repeating an action, activity or section within a program.
Operator	A character which determines what action is to be considered or determined. Example: =
Relational Operator	An operator which compares two values. Example: <
Subroutine	A section of code written outside of the main program. Covers procedures and functions.

Variable	A memory location within a computer where values are stored.
----------	--------------------------------------------------------------

```

Input/Output and Calculation
userInputName = input("Enter your name: ") userNum =
int(input("Enter an integer: ")) userDec = float(input("Enter a
decimal number: "))
calculation = userNum + userDec
print("Hello", userInputName, "the result is", calculation)
Enter your name: Mr. Weston Enter an integer: 3 Enter a decimal
number: 15.2 Hello Mr. Weston the result is 18.2

IF Statements
print("Press 1 for a greeting. Press 2 for a farewell.") userChoice =
int(input("Awaiting Input: "))
if userChoice == 1: print("Hello User!")
elif userChoice == 2: print("Goodbye User!")
else:
    print("Error - 1 or '2' not detected.")
    
```

```

Press 1 for a greeting. Press 2 for a farewell Awaiting Input: 1
Hello User!
>>>
Press 1 for a greeting. Press 2 for a farewell Awaiting Input: 2
Goodbye User!
>>>
Press 1 for a greeting. Press 2 for a farewell
Awaiting Input: 3
Error - '1' or '2' not detected.
    
```

```

LOOPS
(userChoice = "Yes"
while userChoice == "Yes":
    userChoice = input ("Do you want to repeat this? ")
    
```

```

userCount = int(input("How many times do you want to use this
loop? "))
forx in range (1, userCount+1): print("You asked for this many.")
    
```

```

Do you want to repeat this? Yes Do you want to repeat this? Yes
Do you want to repeat this? No thank you.
How many times do you want to use this loop? 3 You asked for
this many.
You asked for this many.
You asked for this many.
    
```



Term	Definition
	The process of removing all unnecessary details from a problem.
	The sequence of steps required to carry out a specific task.
	Setting the value of a variable in a computer program.
	Units of information which is acted upon by instructions.
	Breaking down a problem into smaller steps that are easier to work with and solve.
	A diagram which shows the step by step flow of an algorithm.
	Data which is inserted into a system to be processed or stored.
	Data which is sent out of a system.
	An action taken by the program without input from the user.
	A method of writing an algorithm using plain English.
	A memory location within a computer where values are stored

Data Type	Explanation	Example
	TRUE/FALSE or 1/0	
	A single, alphanumeric character.	
	Whole numbers	
	One or more alphanumeric characters.	
	Decimal numbers	

Flowchart Symbol	Name	Usage
Start/Stop	Terminator	
Process	Process	
	Input/	
w Input/ M	Output	
* Output		
	Decision	

Common Algorithms	Explained
	Compares the search object to the middle point of a sorted list. If they are not equal, the half in which the target cannot lie is eliminated and the search continues on the remaining half, again taking the middle point to compare to the search object, and repeating this until the target value is found or the end is reached.
	Sorts a list by continuously stepping through a list, swapping items until they appear in the correct order.
	Compares the search object with each item in the list in order from the beginning until it is found or the end is reached.
	Sorts a list by repeatedly dividing a list into two until all the elements are separated individually. Pairs of elements are then compared, placed into order and combined. The process is then repeated until the list is recompiled in the correct order as a whole.

Term	Definition
	A mathematical character to perform a calculation. Example: +
	A set of values, of the same data type, stored in sequence. A list.
	Setting or changing the data type of a variable.
	Connecting strings of characters together.
	A statement which is either true or false. A computation depends on whether a condition is true or false.
	A value which does not change whilst the program is running.
	An individual item in an array. A value in a list.
	Anything you can save. Document, piece of music, data etc.
	A name, usually for part of the program such as a constant, variable, array etc.
	A statement that lets a program select an action depending on whether it is true or false.
	Repeating an action, activity or section within a program.
	A character which determines what action is to be considered or determined. Example: =
	An operator which compares two values. Example: <
	A section of code written outside of the main program. Covers procedures and functions.

Variable	A memory location within a computer where values are stored.
----------	--------------------------------------------------------------

```

Input/Output and Calculation
userInputName = input("Enter your name: ") userNum =
int(input("Enter an integer: ")) userDec = float(input("Enter a
decimal number: "))
calculation = userNum + userDec
print("Hello", userInputName, "the result is", calculation)
Enter your name: Mr. Weston Enter an integer: 3 Enter a decimal
number: 15.2 Hello Mr. Weston the result is 18.2

IF Statements
print("Press 1 for a greeting. Press 2 for a farewell.") userChoice =
int(input("Awaiting Input: "))
if userChoice == 1: print("Hello User!")
elif userChoice == 2: print("Goodbye User!")
else:
    print("Error - 1 or '2' not detected.")
    
```

```

Press 1 for a greeting. Press 2 for a farewell Awaiting Input: 1
Hello User!
>>>
Press 1 for a greeting. Press 2 for a farewell Awaiting Input: 2
Goodbye User!
>>>
Press 1 for a greeting. Press 2 for a farewell
Awaiting Input: 3
Error - '1' or '2' not detected.
    
```

```

LOOPS
(userChoice = "Yes"
while userChoice == "Yes":
    userChoice = input ("Do you want to repeat this? ")
    
```

```

userCount = int(input("How many times do you want to use this
loop? "))
for x in range (1, userCount+1): print("You asked for this many.")
    
```

```

Do you want to repeat this? Yes Do you want to repeat this? Yes
Do you want to repeat this? No thank you.
How many times do you want to use this loop? 3 You asked for
this many.
You asked for this many.
You asked for this many.
    
```



GCSE Business. Paper 1 1. Enterprise and Entrepreneurship



1. The Dynamic Nature of Business

Term	Definition
Dynamic Nature of Business	The idea that Business is ever-changing because external factors such as technology and legislation are always changing.
Venture Capital	Capital provided by an investor willing to take a risk in return for profit in the future

2. Why start a Business?

Starting a Business	Explanation
Why?	<ul style="list-style-type: none"> A desire to succeed Financial Reward Independence and a desire to be your own boss
Who?	<p>A successful start-up requires a huge list of qualities and skills, especially if starting up on your own.</p> <p>Among these are:</p> <p>Personal Qualities: Determination, resilience, enthusiasm, hard-working, decisive and willing to take risks</p> <p>Skills: Can listen as well as speak, can plan and organize, can influence and manage others.</p> <p>Resources: Can find help when needed, may have unique skills.</p>
How?	When people need to raise capital to help them start a business, they write a business plan. This sets out the aims, objectives, the strategies to be used, the financial forecasts and requirements.

3. Why new business ideas come about:

Why?	Explanation
Changes in what consumers want	Consumers desires and tastes change all the time. These changes create markets for entrepreneurs to invest in.
Products and services becoming obsolete	Products can become obsolete due to changes in technology and consumer wants.
Changes in Technology	Changes in technology can lead to improvements in existing products, the creation of new ones and help in making business more efficient.

Key Terms and Definitions	
Demand	The number of units that customers want and can afford to buy
Entrepreneurs	Businesspeople who see opportunities and are willing to take risks in making them happen.
Obsolete	A product or a service with sales that have declined or come to an end as customers find something new.

4. How new business ideas come about:

Term	Definition
Adapting existing products	Developing new products based on existing products.
Competitive Advantage	A feature of business that helps it to succeed against rivals.
Original Ideas	Ideas that have not been done before.

4. Risks and Rewards of starting a new Business

Risks	Rewards
<p>Business Failure</p> <p>50% of new Businesses fail within the first five years. One of the biggest risks of starting a new business is that may not be viable.</p>	<p>Success</p> <p>Success and a sense of achievement are an integral part of business. When a business is successful this comes with a huge sense of pride and satisfaction for the entrepreneur</p>
<p>Financial Loss</p> <p>If a business gets into financial trouble this can lead to bankruptcy and considerable debts that cannot be repaid.</p>	<p>Profit and Wealth</p> <p>If the business is successful it can generate huge returns. Income and wealth are a huge motivator for a potential entrepreneur.</p>
<p>Lack of Security</p> <p>When starting a new business there are many uncertainties. Will the Business be successful? Will the Business provide a income? The lack of certainty and financial security is a major risk when starting a business.</p>	<p>Independence</p> <p>By becoming independent, entrepreneurs make their own decisions and if necessary, their own compromises. Being your own boss and making decisions without external influence can be a powerful motivator when starting your own business.</p>

5. Risk and Rewards of Business

Term	Definition
Business Failure	The collapse of a business, probably leading to its closure.
Independence	The need by many business owners to make their own decisions and be their own boss.
Lack of Financial Security	Uncertainty for the business owner about day to day family income and assets
Risk and Reward	The balance between the worst that can happen and the best that can happen

6. The Role of Business Enterprise - Definitions

Term	Definition
Customer Needs	The products or services people need in order to live.
Customer Wants	The products or services people need in order to make life more comfortable.
Goods	Products that may be fresh, such as apples, or manufactured, such as Heinz baked beans. Items you can actually touch.
Services	Providing useful ways to help people with their lives, for examples mechanics, hairdressers and hospitals. Intangible products.

7. Adding Value

Term	Definition
Branding	Giving a product or service 'personality' with a name and logo that makes it stand out.
Unique Selling Point	An original feature of a product that rivals aren't offering.
Value Added	The difference between the selling price and the cost of bought in goods and services (the difference that creates the possibility of profit).

8. Role of Entrepreneurship

Qualities needed	Explanation
Ability to take risks	Entrepreneurs are willing to take risks and seize new opportunities
Making decisions	Making the right decisions given the information is available is crucial to the success of any entrepreneur
Showing Leadership	Leadership is crucial displaying qualities such as decisiveness, initiative and the ability to think ahead
Organising Resources	Being able to organize resources such as human, physical or daily resources are crucial to the smooth running of any start-up



1. The Dynamic Nature of Business	
Term	Definition
Dynamic Nature of Business	
Venture Capital	

2. Why start a Business?	
Starting a Business	Explanation
Why?	
Who?	
How?	

3. Why new business ideas come about:	
Why?	Explanation
Changes in what consumers want	
Products and services becoming obsolete	
Changes in Technology	
Key Terms and Definitions	
Demand	
Entrepreneurs	
Obsolete	

4. How new business ideas come about:	
Term	Definition
Adapting existing products	
Competitive Advantage	
Original Ideas	

4. Risks and Rewards of starting a new Business	
Risks	Rewards
Business Failure	Success
Financial Loss	Profit and Wealth
Lack of Security	Independence

6. The Role of Business Enterprise - Definitions	
Term	Definition
Customer Needs	
Customer Wants	
Goods	
Services	

5. Risk and Rewards of Business	
Term	Definition
Business Failure	
Independence	
Lack of Financial Security	
Risk and Reward	

7. Adding Value	
Term	Definition
Branding	
Unique Selling Point	
Value Added	

8. Role of Entrepreneurship	
Qualities needed	Explanation
Ability to take risks	
Making decisions	
Showing Leadership	
Organising Resources	

Name: _____

Date: _____

Macronutrients, fibre and water



Macronutrients

Macronutrients provide energy. The macronutrients are:

- carbohydrate;
- protein;
- fat.

Macronutrients are measured in grams (g).

Alcohol

Alcohol is not considered a nutrient, but is a source of energy in the diet.

The government recommends no more than 14 units of alcohol per week for both men and women.

Energy from food

- Energy intake is measured in joules (J) or kilojoules (kJ), but many people are more familiar with Calories (kcal).
- Different macronutrients, and alcohol, provide different amounts of energy.

	Energy per gram
Carbohydrate	16kJ (3.75 kcals)
Protein	17kJ (4 kcals)
Alcohol	29kJ (7kcals)
Fat	37kJ (9 kcals)

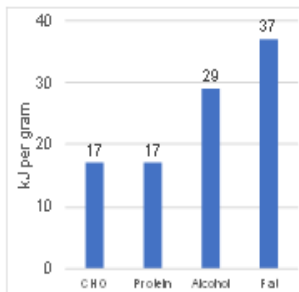

Protein

- Made up of building blocks called amino acids.
- There are 20 amino acids found in protein.
- Eight amino acids have to be provided by the diet (called essential amino acids).

The essential amino acids are isoleucine, leucine, lysine, methionine, phenylalanine, threonine, tryptophan and valine.

In young children, additional amino acids, e.g. histidine and tyrosine, are sometimes considered to be essential (or 'conditionally essential') because they may be unable to make enough to meet their needs.

Recommendations

- 0.75g/kg bodyweight/day in adults.

Sources:

Animal sources: meat; poultry; fish; eggs; milk; dairy food.

Plant sources: soya; nuts; seeds; pulses, e.g. beans, lentils; mycoprotein.

Protein complementation

Different food contains different amounts and combinations of amino acids.

Vegans and vegetarians can get all the amino acids they need by combining different protein types at the same meal. This is known as protein complementation.

Examples are:

- rice and peas;
- beans on toast;
- hummus and pitta bread;
- bean chilli served with rice.

Carbohydrate

All types of carbohydrate are compounds of carbon, hydrogen and oxygen. They can be divided into three main groups according to the size of the molecule.

These three types are:

- monosaccharides (e.g. glucose);
- disaccharides (e.g. lactose);
- polysaccharide (e.g. sucrose).

The two types main of carbohydrate that provide dietary energy are starch and sugars. Dietary fibre is also a type of carbohydrate.

Starchy carbohydrate is an important source of energy.

Starchy foods - we should be choosing wholegrain versions of starchy foods where possible.

Recommendations

- Total carbohydrate - around 50% of daily food energy.
- Free sugars include all sugars added to foods plus sugars naturally present in honey, syrups and unsweetened fruit juice (<5% daily food energy).
- Fibre is a term used for plant-based carbohydrates that are not digested in the small intestine (30g/day for adults).

Fibre

- Dietary fibre is a type of carbohydrate found in plant foods.
- Food examples include wholegrain cereals and cereal products; oats; beans; lentils; fruit; vegetables; nuts; and, seeds.

Dietary fibre helps to:

- reduce the risk of heart disease, diabetes and some cancers;
- help weight control;
- bulk up stools;
- prevent constipation;
- improve gut health.

Fat

Sources of fat include:

- saturated fat;
- monounsaturated fat;
- polyunsaturated fat.

Fats can be saturated, when they have no double bonds, monounsaturated, when they have one double bond, or polyunsaturated, when they have more than one double bond.

Recommendations

- <35% energy, Saturated fat <11% energy.

A high saturated fat intake is linked with high blood cholesterol levels.

Sources:

Saturated fat: fatty cuts of meat; skin of poultry; butter; hard cheese; biscuits, cakes and pastries; chocolate.
Monounsaturated fat: edible oils especially olive oil; avocados; nuts.
Polyunsaturated fatty acids: edible oils especially sunflower oil; seeds; margarine; spreadable fats made from vegetable oils and oily fish.

Dietary reference values (DRVs) are a series of estimates of the energy and nutritional requirements of different groups of healthy people in the UK population. They are not recommendations or goals for individuals.

Reference Intakes are guidelines for the maximum amount of energy (calories), fat, saturated fat, sugars and salt consumed in a day (based on a healthy adult female).

Key terms

Dietary reference values: Estimated dietary requirements for particular groups of the population.

Essential amino acids: 8 of the different amino acids found in proteins from plants and animals that have to be provided by the diet.

Macronutrients: Nutrients needed to provide energy and as the building blocks for growth and maintenance of the body.

Protein complementation: combining different protein types at the same meal to ensure all EAAs are ingested.

Reference Intakes: Guidelines for the maximum amount of nutrients consumed.

Hydration

- Aim to drink 6-8 glasses of fluid every day.
- Water, lower fat milk and sugar-free drinks including tea and coffee all count.
- Fruit juice and smoothies also count but should be limited to no more than a combined total of 150ml per day.

20% of water is provided by food such as soups, yogurts, fruit and vegetables.

The other 80% is provided by drinks such as water, milk and juice.

Drinking too much water can lead to 'water intoxication' with potentially life threatening hyponatraemia.

This is caused when the concentration of sodium in the blood gets too low.

Micronutrients

Micronutrients are needed in the body in tiny amounts. They do not provide energy, but are required for a number of important processes in the body.

There are two main groups of micronutrients:

- vitamins;
- minerals and trace elements.

Micronutrients are measured in milligrams (mg) and micrograms (µg) with 1mg = 0.001g and 1µg = 0.001mg.

Micronutrient recommendations
People have different requirements for each micronutrient, according to their:

- age;
- gender;
- physiological state (e.g. pregnancy).



Micronutrient recommendations

The recommendations for vitamins and minerals are based on the **Reference Nutrient Intake (RNI)**.

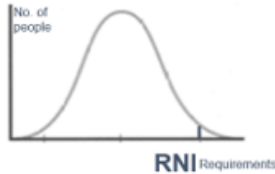

When looking at low intakes of micronutrients, the **Lower Reference Nutrient Intake (LRNI)** is used.

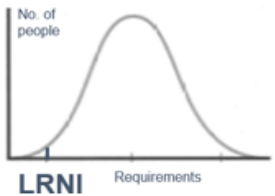

For more information, go to: <https://bit.ly/36KUnji>

Vitamins
Vitamins are nutrients required by the body in small amounts, for a variety of essential processes.

Most vitamins cannot be made by the body, so need to be provided in the diet.

Vitamins are grouped into:

- fat-soluble vitamins (vitamins A, D, E and K);
- water-soluble vitamins (B vitamins and vitamin C).

Minerals
Minerals are inorganic substances required by the body in small amounts for a variety of different functions.

The body requires different amounts for each mineral.

Some minerals are required in larger amounts, while others are needed in very small amounts and are called 'trace elements'.

Vitamins

Nutrient	Function	Sources
Vitamin A	Helps the immune system to work as it should and with vision.	Liver, cheese, eggs, dark green leafy vegetables and orange-coloured fruits and vegetables.
B vitamins	Thiamin , riboflavin, niacin, folate, and vitamin B12 have a range of functions within the body.	Different for each B Vitamin.
Vitamin C	Helps to protect cells from damage and with the formation of collagen.	Fruit (especially citrus fruits), green vegetables, peppers and tomatoes.
Vitamin D	Helps the body to absorb calcium & helps to keep bones strong.	Oily fish, eggs, fortified breakfast cereals and fat spreads.
Vitamin E	Helps to protect the cells in our bodies against damage.	Vegetable and seed oils, nuts and seeds, avocados and olives.
Vitamin K	Needed for the normal clotting of blood and is required for normal bone structure.	Green vegetables and some oils (rapeseed, olive and soya oil).

Minerals

Nutrient	Function	Sources
Calcium	Helps to build and maintain strong bones and teeth.	Dairy, calcium-fortified dairy-alternatives, canned fish (where soft bones are eaten) and bread.
Iron	Helps to make red blood cells, which carry oxygen around the body.	Offal, red meat, beans, pulses, nuts and seeds, fish, quinoa, wholemeal bread and dried fruit.
Phosphorus	Helps to build strong bones and teeth and helps to release energy from food.	Red meat, poultry, fish, milk, cheese, yogurt, eggs, bread and wholegrains.
Sodium	Helps regulate the water content in the body.	Very small amounts found in foods. Often added as salt.
Fluoride	Helps with the formation of strong teeth and reduce the risk of tooth decay.	Tap water, tea (and toothpaste).
Potassium	Helps regulate the water content in the body and maintain a normal blood pressure.	Some fruit and vegetables, dried fruit, poultry, red meat, fish, milk and wholegrain breakfast cereals.
Iodine	Helps to make thyroid hormones. It also helps the brain to function normally.	Milk, yogurt, cheese, fish, shellfish and eggs.

Key terms
Micronutrients: Nutrients needed in the diet in very small amounts.

Lower Reference Nutrient Intake (LRNI): is the amount of a nutrient that is enough for only the small number of people who have low requirements (2.5%). The majority of people need more.

Reference Nutrient Intake (RNI): the amount of a nutrient that is enough to ensure that the needs of nearly all the group (97.5%) are being met. The RNI is used for recommendations on protein, vitamins and minerals.

Vitamin D
Vitamin D is a pro-hormone in the body. It can be obtained in two forms:

- ergocalciferol (vitamin D₂);
- cholecalciferol (vitamin D₃).

Vitamin D₃ is also formed by the action of sunlight. Different to most vitamins, the main source of vitamin D is synthesis in the skin following exposure to sunlight. The wavelength of UVB during the winter months in the UK does not support vitamin D synthesis.



Frayer Model Key Words

Protein	A macronutrient that is essential to building muscle mass.
Fat	A macronutrient which supplies the body with energy.
Carbohydrates	A macronutrient that is required by all animals. It is made in plants by the process of photosynthesis.
Vitamin	Vitamins are split into two categories, water soluble and fat soluble. Fat soluble vitamins (A, D E, and K) dissolve in fat. Water soluble vitamins (the B group and vitamin C) dissolve in water.
Nutritional	Providing or obtaining the food necessary for health and growth.
Energy	The strength and vitality required for sustained physical or mental activity.



QUIZ

Macronutrients

Macronutrients provide energy. The macronutrients are:

- .
- .
- .

Macronutrients are measured in..... ().

Micronutrients are needed in the body inamounts. They do not provide....., but are required for a number of important.....in the body.

There are two main groups of micronutrients:

- .
- .

Micronutrients are measured in (mg) and (µg) with 1mg = 0.001g and 1µg = 0.001mg.

Key terms

Dietary reference values:

Essential amino acids:

Macronutrients:

Protein complementation:

Reference Intakes:

Protein

Made up of building blocks called

There are amino acids found in protein. Eight amino acids have to be provided by the diet (called..... amino acids).

Sources:

Animal sources:

Plant sources:

Vitamins

Vitamins are nutrients required by the body in small amounts, for a variety of essential processes.

Most vitamins cannot be made by the body, so need to be provided in the diet.

Vitamins are grouped into:

-

-

Protein complementation

Different food...

Vegans and vegetarians can get all the amino acids they need by combining different protein types at the same meal. This is known as protein complementation.

Examples are:

- .
- .
- .
- .
- .

Carbohydrate

All types of carbohydrate are compounds of carbon, hydrogen and oxygen. They can be divided into three main groups according to the size of the molecule.

These three types are:

-
-
-

The two types main of carbohydrate that provide dietary energy are starch and sugars. Dietary fibre is also a type of carbohydrate.

Starchy carbohydrate is an important source of energy.

Starchy foods –

Recommendations

- Total carbohydrate – around.....of daily food energy.
- Free sugars includeplus sugars naturally present in honey, syrups and unsweetened fruit juice (<5% daily food energy).
- Fibre is a term used for plant-based carbohydrates that are not digested in the small intestine (30g/day for adults).

Key terms

Micronutrients:

.

Lower Reference Nutrient Intake (LRNI):

Reference Nutrient Intake (RNI):

Fat

Sources of fat include: saturated fat; monounsaturated fat; polyunsaturated fat.

Fats can be saturated, when they have no double bonds, monounsaturated, when they have one double bond, or polyunsaturated, when they have more than one double bond.

Recommendations

<35% energy, Saturated fat <11% energy.

A high saturated fat intake is linked with high blood cholesterol levels.

Sources:



Year 10 PRODUCT DESIGN Term 1



What we are learning this term:

- A. Scales of Production C. Impact on Enterprise E. Impact on People G. Ergonomics
 B. Production Methods D. Anthropometric Data F. Impact on Design

A. Scales of Production		
Type	How Many?	Examples
One-off Production 	1	<ul style="list-style-type: none"> Towers /bridges Bespoke house Custom made clothes
Batch Production 	10s-1000s	<ul style="list-style-type: none"> Baked Foods Limited Edition Socks Chairs
Mass Production 	10,000s – 100,000s	<ul style="list-style-type: none"> Cars Bottles Microchips Plain shirts
Continuous Production 	100,00s+	<ul style="list-style-type: none"> Energy Water Paper Plastic

B. Production Methods	
	Flexible Manufacturing Systems (FMS)
This is where automated machines are adaptable and can produce different products if needed.	
	Lean Manufacturing
This is where waste and energy is kept to a minimum. This saves money and resources in production, as well as helping minimise the environmental impact of producing products.	
	Just-in-Time (JIT) Manufacturing
This is where manufacturers only order materials, parts, etc, when needed. This can be used in any scale of production but its particularly useful for one-off production.	

C. Impact on Enterprise	
Crowdfunding 	A way of raising money from large numbers of people to launch a new product through websites.
Virtual marketing and retail 	Promotion of products online and sharing experiences, reviews and recommendations.
Cooperatives 	A business that is owned and managed by it's workers, all working towards a common goal.
Fair trade 	An organisation that helps workers have fair trading and working conditions in developing countries

D. Anthropometric Data	
The study of human measurements to ensure the products and environments are the correct size for the intended user.	

E. Impact on People	
Technology Push 	When technological discoveries are used to drive the development or creation of a product
Market Pull 	When products are developed or created to meet the needs of society or a gap in the market.
Universal Design 	When designs are focused on serving the broadest range of users possible, rather than trying to address individual accessibility or inclusion objectives.
Inclusive Design 	When the designer focuses on exploring ways of serving a full spectrum of people, regardless of age, gender, and disability.
User Centred Design (USD) 	When designers focus on the end-user's wants and needs in each phase of the design process.

F. Impact on Design	
Planned obsolescence	Designing products that will have a limited life and that will become obsolete and require to be replaced, such as disposable razors.
Design for Maintenance	Designing products that are more durable and have spare parts available to mend and maintain them, such as a push bike.
Design for Disassembly	When a product has reached the end of its life it can be taken apart and parts reused or recycled, such as a school seat.
Environmental Design	Designing products to be more sustainable and improving the overall environmental impact of a product, such as paper straws.

G. Ergonomics	
This is the consideration that leads to a product being designed in a way that makes it easy to use. Such as a person sitting at their computer desk or the type of water bottle they use.	



Year 10 PRODUCT DESIGN Term 1



What we are learning this term:

- A. Scales of Production C. Impact on Enterprise E. Impact on People G. Ergonomics
- B. Production Methods D. Anthropometric Data F. Impact on Design

A. Scales of Production		
Type	How Many?	Examples
One-off Production 		
Batch Production 		
Mass Production 		
Continuous Production 		

B. Production Methods	
	Flexible Manufacturing Systems (FMS)
	Lean Manufacturing
	Just-in-Time (JIT) Manufacturing

C. Impact on Enterprise	
Crowdfunding 	
Virtual marketing and retail 	
Cooperatives 	
Fair trade 	

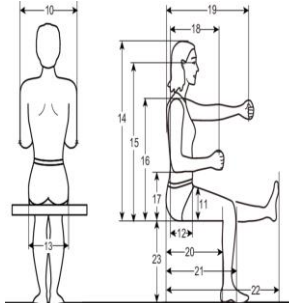
D. Anthropometric Data	
	

E. Impact on People

Technology Push 	
Market Pull 	
Universal Design 	
Inclusive Design 	
User Centred Design (USD) 	

F. Impact on Design

Planned obsolescence	
Design for Maintenance	
Design for Disassembly	
Environmental Design	

G. Ergonomics

--	--



What we are learning this term:	
A.	Understanding professional works
B.	What is a professional work
C.	What is a practitioner
D.	How do we analyse a performance
E.	What are physical skills
F.	What are interpretive skills
G.	Three different performance styles / genres

6 Key Words for this term	
1 Practitioners	4 Performance material
2 Physical skills	5 Analyse
3 Interpretive skill	6 Intentions

A.	Key question – What is the artistic purpose of a performance work?
<p>When watching a professional performance, the key questions you need to think about are the following...</p> <p>How do we Explore artistic purpose?</p> <p>Explore artistic purpose (across all three disciplines/styles) including:</p> <ul style="list-style-type: none"> to educate to inform to entertain to provoke to challenge viewpoints to raise awareness to celebrate. 	

A.	Component 1 – Key focus
<p>In this component, you will develop your understanding of drama by examining the work of the practitioners: Stanislavski, Splendid Productions and Mark Wheeler. The practitioners cover the genres: Naturalism, Epic Theatre and physical visual storytelling. You will explore the processes used to create performance by working through the processes yourselves. At the same time you will research the job roles and responsibilities within the industry that enable shows to happen.</p> <p>You will experience a range of work across the discipline of drama by viewing recorded and/or live work. We will aim to go to live shows in Bristol, London and the surrounding area in order to absorb as many different styles as possible.</p> <p>While this is primarily a theoretical study of the performing arts practical investigations, students will be working at developing practical skills through workshops and links with Component 2 Developing Skills and Techniques in the Performing Arts, to engage in primary exploration of specific repertoire</p>	

C.	Key question from Assessment objectives
<ol style="list-style-type: none"> 1. What are physical skills 2. What are interpretive skills 3. How do we use these skills practically? 4. How do we IMPROVE on these skills? 	<ol style="list-style-type: none"> 1. What is a professional work 2. What is a practitioner 3. How do we analyse a performance 4. What are a practitioners creative intentions

G.	Key learning aims from Component 1
<p><i>Learning aim A: Examine professional practitioners' performance work</i></p>	<p>A1: Professional practitioners' performance material, influences, creative outcomes and purpose</p> <p>Examine live and recorded performances in order to develop understanding of practitioners' work with reference to influences, outcomes and purpose.</p> <p>Focus on thematic interpretation of particular issues and how artists communicate their ideas to an audience.</p> <p>Roles and responsibilities in theatre.</p>
<p><i>Learning aim B: Explore the interrelationships between constituent features of existing performance material</i></p>	<p>Processes used in performance</p> <ul style="list-style-type: none"> ● Responding to stimuli to generate ideas for performance material. ● Exploring and developing ideas to develop material. ● Discussion with performers. ● Setting tasks for performers. ● Sharing ideas and intentions. ● Providing notes and/or feedback on improvements.

E.	Keywords
Practitioners	A professional theatre maker who creates in a specific style led by a specific theatre ideology.
Performance material	The practical work that a practitioner creates for performance.
Creative Intentions	The ideas behind the choreography, why the choreographer choose to create the work.
Review	Look over your current work and the work of others and be able to review and comment on your own and others practice
Analyse/ Evaluate	Watch and then analyse your own performance and the work of others and giving comments and judgements on what you see
Influences	How the practitioner has been influenced by others, their experiences, their training and how this has affected the work they create.
Physical skills	The physical attributes that an actor uses, stamina, strength, flexibility, control, to dance with technical accuracy.



What we are learning this term:	
A.	Understanding professional works
B.	What is a professional work
C.	What is a practitioner
D.	How do we analyse a performance
E.	What are physical skills
F.	What are interpretive skills
G.	Three different performance styles / genres

6 Key Words for this term	
1 Practitioners	4 Performance material
2 Physical skills	5 Analyse
3 Interpretive skill	6 Intentions

A.	Key question – What is the artistic purpose of a performance work?
<p>When watching a professional performance, the key questions you need to think about are the following... How do _____? (across all three disciplines/styles) including: to _____ to _____ to _____ to _____ to _____ to _____</p>	

A.	Component 1 – Key focus
<p>In this component of the qualification students will develop their understanding of drama by examining the work of _____s and the _____ used to _____.</p> <p>Students should experience a range of work across the discipline of drama by viewing recorded and/or live work.</p> <p>While this is primarily a theoretical study of the performing arts practical investigations, students will be working at developing practical skills through _____s and links with Component 2 _____ and Te_____s in the Performing Arts, to engage in primary exploration of specific repertoire.</p>	

C.	Key question from Assessment objectives
<ol style="list-style-type: none"> 1. What are physical skills 2. What are interpretive skills 3. How do we use these skills practically? 4. How do we IMPROVE on these skills? 	<ol style="list-style-type: none"> 1. What is a professional work 2. What is a practitioner 3. How do we analyse a performance 4. What are a practitioners creative intentions

G.	Key learning aims from Component 1
<p><i>Learning aim A: Examine professional practitioners' performance work</i></p>	<p>A1: Professional practitioners' performance material, influences, creative outcomes and purpose</p> <p>Examine _____ and _____ performances in order to develop _____ of practitioners' work with reference to _____s, o_____s and p_____se. Focus on _____ i_____ of particular i_____ and how artists c_____te their ideas to an _____e. Roles and responsibilities in theatre.</p>
	<p><i>Learning aim B: Explore the interrelationships between constituent features of existing performance material</i></p> <p>Processes used in performance</p> <ul style="list-style-type: none"> • Responding to _____ to generate id_____s for performance material. • Exploring and developing ideas to develop material. • D_____on with performers. • Setting _____ for performers. • S_____ng ideas and intentions. • Providing _____ and/or fe_____ck on imp_____nts.

E.	Keywords
Practitioners	
Performance material	
Creative Intentions	
Review	
Analyse/ Evaluate	
Influences	
Physical skills	

What we are learning during this unit:	
A. Job Roles in the Music Industry B. Employment Patterns C. Record Labels (Pros and Cons) D. Venues / Health and Safety / Security E. Unions/Agencies/Trade Bodies F. Publishing (Pros and Cons)	
6 Key Words for this term	
1 Employment	4 Responsibility
2 Major	5 Union
3 Independent	6 Publishing

B. Employment Patterns	
Fulltime	5 days a week, Contract (holidays/sick pay and pension)
Part time	1-4 days a week, Contract like full time.
Freelance	Self-employed, no long-term contracts! No work = no pay
Permanent Vs Casual	Permanent = guaranteed work / security whereas casual is not secure, varies but does give more flexibility
C. Record Labels (pros and cons)	

E. Unions/Agencies/Trade Bodies	
Agencies  MCPS / PRS Mechanical-Copyright Protection Society and the Performing Right Society. Collects royalties for musicians for physical formats like CD (MCPS) and live music (PRS)	
PPL = Phonographic Performance Limited. Licenses the right to perform recorded music 	
Unions Unions provide support for lots of people, they provide things like advice for freelancers on NI/TAX, handling disputes, and support in negotiating contracts	
 MU = Musicians Union Equity BECTU = Broadcasting Entertainment Cinematograph Theatre Union	
Trade bodies  MPG = Music Producers Guild Represents people involved in producing recorded music  PLASA = Professional Lighting and Sound Association Represents those who work/supply technologies  APRS = Association of Professional Recording Services Represents those who work in the audio industry, e.g. recording studios/producers	

A. Job Roles in the Music Industry	
Key word	Key definition
✓ Musician	Plays an instrument or voice
✓ Composer	Writes music e.g. films
✓ Songwriter	Writes songs
✓ Record producer	Directs recording sessions
✓ Conductor	Directs an orchestra / ensemble
✓ Live Sound Technician	Monitors sound at live events Moves equipment /sets up
✓ Roadie	Fixes stuff like guitars/drums
✓ Instrument Technician	The boss of the artist/band! Responsible for health/safety
✓ Artistic Manager	Book recordings/H&S
✓ Venue Manager	Sells tickets to live events!
✓ Studio Manager	Finds new talent to sign to labels
✓ Promoter / Marketer	
✓ A&R	Records the music in studio
✓ Sound Engineer	Plays in recordings or live shows
✓ Session Musician	Perfects finished recording
✓ Mastering Engineer	Makes the CD's to sell
✓ Music Journalist	Writes about music / reviews
✓ Blogger/Vlogger	Blogs about music / reviews
✓ Broadcaster	E.g. Radio Presenters
✓ Software Programmer	Codes musical software Mixes/plays live music
✓ DJ	Sells merchandise!
✓ Retailer	Gets finished CD's to shops to sell
✓ Distributer	(now also done online!)
✓ Stylist	Works on the band/artist image
✓ Accompanist	Attends auditions, plays for a solo musician e.g. piano

Major	Independent
e.g. Warner, Sony, Universal	Smaller labels
Pros = lots of money, links with companies to promote and publish, lots of contacts, get the best deals for manufacturing, good links with advertising and media to promote and market artist/band Cons = difficult to stand out, less control over your music, contracts can be unfair	Pros = individual style of artist is important, more control over music, closer relationships, contracts more artist friendly Cons = not as much money, less publicity and promotion, not as organised/connected, less media contacts

D. Venues/Health and Safety/Security

Large Venue = Arena
Small Venue = school hall/pub



Health and Safety

Risk Assessment = to identify and minimise risks
HSE = health and safety executive

Security

ID/Bags/Crowd Control









F. Publishing (pros and cons)

Major	Self-Publishing
Remember: Publishing Company = Composition OWNERSHIP	
Pros = good distribution, payment often upfront (in advance), marketing and promotion is good Cons = signed through an agent (which means they take a cut!), harder to get published when the company is huge, more editing done on your work so less control	Pros = no need for an agent, send work directly, done on social media, more in control of editing, stepping stone to a larger company Cons = less money, less marketing and promotion

What we are learning during this unit:	
A. Job Roles in the Music Industry B. Employment Patterns C. Record Labels (Pros and Cons) D. Venues / Health and Safety / Security E. Unions/Agencies/Trade Bodies F. Publishing (Pros and Cons)	
6 Key Words for this term	
1 E _____	4 R _____
2 M _____	5 U _____
3 I _____	6 P _____

B. Employment Patterns	
	__ days a week, Contract (holidays/sick pay and pension)
	__ days a week, Contract like full time.
	Self-employed, no long-term c____! No work = no p____
	P_____ = guaranteed work / security whereas casual is not secure, varies but does give more flexibility
C. Record Labels (pros and cons)	

E. Unions/Agencies/Trade Bodies	
Agencies  MCPS / PRS _____ and the Performing Right S_____. Collects royalties for musicians for physical formats like CD (MCPS) and live music (PRS)	
 PPL = Phonographic Performance Limited. Licenses the right to perform recorded music	
Unions Unions provide support for lots of people, they provide things like advice for freelancers on _____, handling disputes, and support in _____	
 MU = Musicians Union Equity BECTU = Broadcasting Entertainment Cinematograph Theatre Union	
Trade bodies  _____ = Music Producers Guild Represents people involved in producing recorded music	
 _____ = Professional Lighting and Sound Association Represents those who work/supply technologies	
 _____ = Association of Professional Recording Services Represents those who work in the audio industry, e.g. recording studios/producers	

A. Job Roles in the Music Industry	
Key word	Key definition
✓ M _____	Plays an instrument or voice
✓ C _____	Writes music e.g. films
✓ S _____	Writes songs
✓ Record p _____	Directs recording sessions
✓ C _____	Directs an orchestra / ensemble
✓ L _____	Monitors sound at live events
Technician	Moves equipment /sets up
✓ R _____	Fixes stuff like guitars/drums
✓ I _____	The boss of the artist/band!
Technician	Responsible for health/safety
✓ Artistic M _____	Book recordings/H&S
✓ V _____ Manager	Sells tickets to live events!
✓ S _____ Manager	Finds new talent to sign to labels
✓ P _____ / Marketer	
✓ A&_____	Records the music in studio
✓ Sound E _____	Plays in recordings or live shows
✓ Session M _____	
✓ M _____ Engineer	Perfects finished recording
✓ M _____	Makes the CD's to sell
✓ Music J _____	Writes about music / reviews
✓ B _____ /Vlogger	Blogs about music / reviews
✓ B _____	E.g. Radio Presenters
✓ S _____	Codes musical software
Programmer	Mixes/plays live music
✓ D _____	Sells merchandise!
✓ R _____	Gets finished CD's to shops to sell (now also done online!)
✓ D _____	
✓ S _____	Works on the band/artist image
✓ A _____	Attends auditions, plays for a solo musician e.g. piano

M _____	I _____
e.g. _____	Smaller labels
Pros = lots of money, links with companies to promote and publish, lots of contacts, get the best deals for manufacturing, good links with advertising and media to promote and market artist/band Cons = difficult to stand out, less control over your music, contracts can be unfair	Pros = individual style of artist is important, more control over music, closer relationships, contracts more artist friendly Cons = not as much money, less publicity and promotion, not as organised/connected, less media contacts

D. Venues/Health and Safety/Security

L _____ Venue = _____
 S _____ Venue = _____



Health and Safety
 _____ = to identify and minimise risks
 HSE = health and safety _____

Security



F. Publishing (pros and cons)

M _____	S _____
Remember: Publishing Company = Composition O _____	
Pros = good distribution, payment often upfront (in advance), marketing and promotion is good Cons = signed through an agent (which means they take a cut!), harder to get published when the company is huge, more editing done on your work so less control	Pros = no need for an agent, send work directly, done on social media, more in control of editing, stepping stone to a larger company Cons = less money, less marketing and promotion



What we are learning this term:

A. *How sport is covered across the media*

A. *Examples of how sport is broadcast across different media platforms*



Main assessment objectives

Learning outcome: Know how sport is covered across the media

C. **What are the different forms of social media?**

Facebook, Twitter, Snapchat and Instagram



A.	Key question from Assessment objectives?	Key definition
1.	Terrestrial TV	Free to air TV
2.	Satellite TV	Requires a monthly payment to watch
3.	Fanzines	Magazines written and published by fans
4.	Blog	An informal or discussion posted online
5.	Podcasts	A digital audio file available online for downloading
6.	P2P Sharing	The distribution and sharing of digital media
7.	Pay-per-view	One off paid for TV events
8.	Fan sites	Websites produced by sports fans

What sports are shown on Pay-per-view channels?

1. Boxing
2. UFC
3. WWE



What satellite channels show sport?

1. Sky
2. BT
3. Virgin



A. **What is the difference between terrestrial, satellite and pay-per-view TV?**

Terrestrial- This TV is free to air, and you must only pay your TV licence to watch this

Satellite- This type of TV requires a monthly subscription to watch

BBC is this type of TV requires a one off payment to watch a live event



A. **What is the difference between a tabloid and broadsheet newspapers?**

Tabloid- A paper that focus on celebrity gossip and news about famous people

Broadsheet- A paper that focus on more serious news such as politics and finance



G. **What sport information are radios likely to broadcast?**

National radio (4)

1. Premier league
2. FIFA World cup
3. Wimbledon
4. Cricket World cup

Examples of national radio

1. Radio 1
2. Radio 2
3. Capital
4. XFM



Local radio (4)

1. STFC results
2. Local rugby results
3. Southern League
4. Bristol football results

Examples of local radio

1. BBC Wiltshire
2. BBC Berkshire
3. Heart Wiltshire
4. STFC Radio



Key information	
Newspapers	The Sun The daily Mail The Guardian The Daily express
Satellite	BT Sky Virgin
Books	Autobiographies Tactics/Plays Sport history
Fanzines	Red issue- Man Utd The Gooner- Arsenal
Blogs	F1 Fanatic Caughtoffside The5krunner
Video-sharing sites	Vimeo Twitch Dailymotion
Live streams	Youtube Facebook Instagram
Magazines	Total carp Runners world Cycling Plus
Terrestrial	BBC ITV Channel 4
Pay-per-view	ITV Box Office Sky Box Office
Dedicates sports radio	Talk sport Radio 5 live
Fan sites	Over the bar

A. **What sports are predominantly shown on TV?**

BBC- Wimbledon/Olympics/Snooker/International football

ITV- International football/Darts/Horse racing

Sky- Premier league football/Cricket/Golf

BT- Champions league football/NBA





What we are learning this term:	
A.	<i>How sport is covered across the media</i>
A.	<i>Examples of how sport is broadcast across different media platforms</i>

Main assessment objectives	
Learning outcome: Know how sport is covered across the media	

Key information	
Newspapers	
Satellite	
Books	
Fanzines	
Blogs	
Video-sharing sites	
Live streams	
Magazines	
Terrestrial	
Pay-per-view	
Dedicates sports radio	
Fan sites	

A.	Key question from Assessment objectives?
Key word	
Key definition	
1. Terrestrial TV	
2. Satellite TV	
3. Fanzines	
4. Blog	
5. Podcasts	
6. P2P Sharing	
7. Pay-per-view	
8. Fan sites	

C.	What are the different forms of social media?
What sports are shown on Pay-per-view channels?	What satellite channels show sport?

A.	What is the difference between terrestrial, satellite and pay-per-view TV?





G.	What sport information are radios likely to broadcast?
National radio (4)	
Local radio (4)	

A.	What is the difference between a tabloid and broadsheet newspapers?

A.	What sports are predominantly shown on TV?





What we are learning this term:	
A.	Key words
B.	What are the main life stages
C.	What are the 4 areas of growth and development (PIES)?
D.	How do Humans develop physically (P)?

A. Key words for this Unit	
Characteristics	Something that is typical of people at a particular life stage.
Life stages	Distinct phases of life that each person passes through.
Growth	Increased body size such as height, weight.
Development	Involves gaining new skills and abilities such as riding a bike.
Gross motor development (G)	Refers to the development of large muscles in the body e.g. Legs
Fine motor development (F)	Refers to the development of small muscles in the body e.g. Fingers
Language development	Think through and express ideas
Contentment	An emotional state when people feel happy in their environment, are cared for and well loved
Self-image	How individuals see themselves or how they think others see them
Self-esteem	How good or bad an individual feels about themselves and how much they value their abilities.
Informal relationships	Relationships formed between family members
Friendships	Relationships formed with people we meet in the home or in situations such as schools, work or clubs
Formal relationships	relationships formed with non-family/friends – such as teachers and doctors.
Intimate relationships	romantic relationships.





B	What are the main life stages?		C	What are the 4 areas of growth and development (PIES)?
Age Group	Life Stage	Developmental Characteristics and Progress	 Physical Development (P)  Intellectual Development (I)  Emotional Development (E)  Social Development (S)	P = growth patterns and changes in the mobility of the large and small muscles in the body that happen throughout life. I = how people develop their thinking skills, memory and language. E = how people develop their identity and cope with feelings. S = describes how people develop friendships and relationships.
0-2 years	Infancy	Sill dependent on parents but growing quickly and developing physical skills.		
3-8 years	Early Childhood	Becoming increasingly independent, improving thought processes and learning how to develop friendships.		
9-18 years	Adolescence	Experiencing puberty, which bring physical and emotional changes.		
19-45 years	Early Adulthood	Leaving home, making own choices about a career and may start a family.		
46-65 years	Middle Adulthood	Having more time to travel and take up hobbies as children may be leaving home; beginning of the aging process.		
65+ years	Later Adulthood	The aging process continues, which may affect memory and mobility.		





D.	How do humans develop physically (P)?
0-2	<ul style="list-style-type: none"> Gross Motor Development (G) = life head, roll over, sit unaided, walk holding onto something, walk unaided, climb stairs, kick and throw, walk upstairs, jump. Fine Motor Development (F) = hold a rattle for short time, reach for an item, pass item from one hand to other, hold between finger and thumb, scribble, build a tower, use a spoon, draw lines and circles, turn page of a book.
3-8	<ul style="list-style-type: none"> G = ride a tricycle, catch a ball with two hands, walk backwards and step to the side, bounce a ball, run on tiptoes, ride a bike, catch a ball with one hand, balance along a thin line. F = hold a crayon to make circles and lines, thread small beads, copy letters and shapes with a pencil, make detailed models with construction bricks, joined up writing, use a needle to sew.
9-18	<ul style="list-style-type: none"> Girls = puberty starts at 10-13 years, breasts grow, hips widen, menstruation begins, uterus and vagina grow. Boys = voice deepens, muscles and strength increase, erections, facial hair, produce sperm. Both = pubic and underarm hair, growth spurts.
19-45	<ul style="list-style-type: none"> Physically mature, sexual characteristics are fully formed, peak of physical fitness, full height, women at most fertile. Later in the life stage people may put on weight, hair turn grey and men may lose hair, women's menstrual cycle was slow down
46-65	<ul style="list-style-type: none"> People may put on weight, hair turn grey and men may lose hair, women's menstrual cycle was slow down. Women go through the menopause – when menstruation ends and they can no longer become pregnant. Men may continue to be fertile throughout life but decrease in sperm production in this life stage.
65+	<ul style="list-style-type: none"> Women's hair becomes thinner, men may lose most of their hair, skin loses elasticity and wrinkles appear, nails hard and brittle, bones weaken, higher risk of contracting infections disease and illness. Stamina, reaction time, muscle and senses (hearing, sight, taste) all reduce.

What we are learning this term:	
A. Key words	
B. What are the main life stages	
C. What are the 4 areas of growth and development (PIES)?	
D. How do Humans develop physically (P)?	
A.	Key words for this Unit
Characteristics	
Life stages	
Growth	
Development	
Gross motor development (G)	
Fine motor development (F)	
Language development	
Contentment	
Self-image	
Self-esteem	
Informal relationships	
Friendships	
Formal relationships	
Intimate relationships	

B	What are the main life stages?		C	What are the 4 areas of growth and development (PIES)? Explain them.
Age Group	Life Stage	Developmental Characteristics and Progress		
0-2 years			Physical Development (P) 	
3-8 years				
9-18 years			Intellectual Development (I) 	
19-45 years			Emotional Development (E) 	
46-65 years				
65+ years			Social Development (S) 	

D.	<u>How do humans develop physically (P)?</u>
0-2	
3-8	
9-18	
19-45	
46-65	
65+	

What we are learning this term:		F. How do humans develop emotionally (E)?	
E. How do humans develop intellectually (I)? F. How do humans develop emotionally (E)? G. How do humans develop socially (S)?			
E. How do humans develop intellectually (I)?			
Infancy 	At birth brains are already well developed. Infants use all of their senses to learn about the world around them. Infancy is a time of rapid intellectual development. At 3 months infants can remember routines. At 9-12 months infants are developing their memory. At 12 months to 2 years infants understand processes and how things work. Language begins to develop during this stage.	Infancy and Early Childhood Bonding and Attachment Bonding and attachment describe the emotional ties an individual forms with others. It starts in the first year of life between infants and their main carer because that person fulfils the infants needs which makes them feel safe and secure.	Adolescence and adulthood Self-image and Self-esteem Self-image is heightened during adolescence because of the physical changes we experience. Our self-esteem can change from day to day based on a variety of factors including employment and health status.
Early childhood 	At 3-4 years of age children become more inquisitive and enjoy exploring objects and materials. They ask lots of questions and enjoy solving simple problems. At 5-6 years old children's memory is becoming well developed. This helps them to talk about the past and anticipate the future.	Security For infants and young children, security is mainly the feeling of being cared for, being safe and loved – it is closely linked with attachment.	Security Adolescence may feel insecure because of puberty. Adults may feel insecure about relationships, job security of income. Later in life adults may feel insecure about staying in their own home or going into a care home. Feeling secure helps us cope better with everyday situations.
Adolescence 	During this time abstract thought is developed – thinking logically and solving complex problems are possible by the end of this life stage. Adolescents may find it difficult to understand the consequences of their actions but they are developing empathy – seeing things from another's point of view.	Contentment Infants and young children are content if they have had enough food, love, are clean and dry and all other needs are met.	Contentment When people feel discontented with aspects of their life – for example, relationships or work – their emotions can be negatively affected.
Early and Middle Adulthood 	By these life stages most adults have a good range of general knowledge. They use this knowledge and experience to solve problems that they come across in their personal and work lives.	Independence Independence is to care for yourself and make your own decisions. Infants are completely dependent on their carer. As children enter early childhood they develop more independence – feed self and get dressed. However, children still need a lot of help from their carer.	Independence Adolescence are dependent on their parents but are beginning to enjoy more independence and freedom to make their own choices. Adults enjoy living independently and controlling their own lifestyle and environment. Later in adulthood people become more dependent on others again.
Later adulthood 	During this life stage people continue to learn and develop intellectually, however, their speed of thinking and memory may decline. This may affect their ability to think through problems and make logical decisions.	G. How do humans develop socially (S)?	
		Life Stage	Types of relationships and social development
		Infancy	<ul style="list-style-type: none"> • Solitary Play - From birth to 2 years, infants tend to play alone although they like to be close to their parent or carer; they may be aware of other children but not play with them.
		Early childhood	<ul style="list-style-type: none"> • Parallel Play - From 2 to 3 years, children enjoy playing next to other children but are absorbed in their own game; they are not socialising or playing with other children. • Cooperative or social play – from 3 years upwards, children start to play with other children; they have developed social skills that help them to share and talk together; they often make up games together, such as being a shopkeeper and customer.
		Adolescence	<ul style="list-style-type: none"> • People become more independent and build more informal and formal relationships. • Social development closely linked to emotions. • Often strongly influenced by peers – 'peer group pressure'.
		Early adulthood	<ul style="list-style-type: none"> • Increased independence means greater control of decisions about informal relationships. • People may be developing emotional and social ties with partners and their own children. • Social life often centred on the family but social skills are required to build and maintain formal relationships.
		Middle adulthood	<ul style="list-style-type: none"> • Children have often left home, but there are likely to still be strong family relationships. • Social circles may expand through travel, spending more time on hobbies or joining new groups.
		Later adulthood	<ul style="list-style-type: none"> • Retired by this stage and so may enjoy more social time with family and friends or join new groups. • However, later in the life stage people may begin to feel isolated if they struggle to get out or if partners and friends pass away.

What we are learning this term:		F. How do humans develop emotionally (E)? Explain each.	
E. How do humans develop intellectually (I)? F. How do humans develop emotionally (E)? G. How do humans develop socially (S)?		Infancy and Early Childhood	
E. How do humans develop intellectually (I)?		Adolescence and adulthood	
Infancy		Bonding and Attachment	
		Self-image and Self-esteem	
		Security	
		Security	
		Contentment	
		Contentment	
Early childhood		Independence	
		Independence	
		G. How do humans develop socially (S)?	
		Life Stage Types of relationships and social development	
Adolescence		Infancy	
		Early childhood	
		Adolescence	
Early and Middle Adulthood		Early adulthood	
		Middle adulthood	
Later adulthood		Later adulthood	
